

# *Design and Evaluation of an Augmented Flute for Beginners*

Master's Thesis at the  
Media Computing Group  
Prof. Dr. Jan Borchers  
Computer Science Department  
RWTH Aachen University



*by*  
*Irene Meiying Cheung Ruiz*

Thesis advisor:  
Prof. Dr. Jan Borchers

Second examiner:  
Prof. Dr. Ulrik Schroeder

Registration date: 23.07.2014  
Submission date: 21.09.2014



I hereby declare that I have created this work completely on my own and used no other sources or tools than the ones listed, and that I have marked any citations accordingly.

Hiermit versichere ich, dass ich die vorliegende Arbeit selbständig verfasst und keine anderen als die angegebenen Quellen und Hilfsmittel benutzt sowie Zitate kenntlich gemacht habe.

*Aachen, September 2015*  
*Irene Meiyang Cheung Ruiz*





# Contents

<b>Abstract</b>	<b>xv</b>
<b>Acknowledgements</b>	<b>xvii</b>
<b>Conventions</b>	<b>xix</b>
<b>1 Introduction</b>	<b>1</b>
1.1 Motivation . . . . .	2
1.2 Contribution . . . . .	3
1.3 Outline . . . . .	3
<b>2 Background and Related Work</b>	<b>5</b>
2.1 Flute Methods for a good embouchure . . . . .	5
2.1.1 Embouchure preparation . . . . .	6
2.1.2 Embouchure placement and blowing	6
2.1.3 Embouchure problems . . . . .	7
2.2 Physics of the flute head joint . . . . .	10
2.2.1 Sound production . . . . .	10

---

2.2.2	Embouchure gestures effects in produced sound . . . . .	12
2.3	Augmented Instruments . . . . .	14
2.3.1	Augmented Flutes and learning environments . . . . .	14
<b>3</b>	<b>Design and Implementation</b>	<b>17</b>
3.1	Observations . . . . .	17
3.2	Hardware prototyping . . . . .	19
3.2.1	Sensing the lip covering . . . . .	19
3.2.2	Sensing air jet . . . . .	25
3.2.3	Sensing lip hole shape . . . . .	29
3.2.4	Other considerations . . . . .	32
3.3	Software prototyping . . . . .	33
3.3.1	Main program . . . . .	33
3.3.2	First design . . . . .	34
3.3.3	Defining thresholds . . . . .	36
3.3.4	Second design . . . . .	39
3.3.5	Third design . . . . .	41
<b>4</b>	<b>Evaluation</b>	<b>47</b>
4.1	User study with experienced players . . . . .	47
4.1.1	Task . . . . .	48
4.1.2	Apparatus . . . . .	48

---

4.1.3	Participants . . . . .	49
4.1.4	Case study design . . . . .	49
4.1.5	Questionnaire . . . . .	49
4.1.6	Results . . . . .	50
4.2	First iteration with beginners . . . . .	52
4.2.1	Task . . . . .	52
4.2.2	Apparatus . . . . .	53
4.2.3	Participants . . . . .	54
4.2.4	Case study design . . . . .	54
4.2.5	Questionnaire . . . . .	54
4.2.6	Results . . . . .	55
4.3	Second iteration with beginners . . . . .	56
4.3.1	Task . . . . .	57
4.3.2	Participants . . . . .	58
4.3.3	Results . . . . .	58
<b>5</b>	<b>Summary and recommendations</b>	<b>69</b>
5.1	Limitations . . . . .	70
5.2	Recommendations . . . . .	71
5.3	Recommendations for future work . . . . .	71
<b>A</b>	<b>The augmented flute circuit</b>	<b>73</b>
A.1	Flow sensor setup . . . . .	73

A.2 The augmented flute schematic . . . . .	73
<b>B Audio processing with PureData</b>	<b>77</b>
<b>Bibliography</b>	<b>79</b>
<b>Index</b>	<b>83</b>

## List of Figures

2.1	Head joint . . . . .	6
2.2	Embouchure . . . . .	7
2.3	Lip placement . . . . .	8
2.4	Split embouchure . . . . .	8
2.5	Standing wave into a pipe . . . . .	11
3.1	Player's chin capacitance . . . . .	20
3.2	Prototype: Foils' placement. G, Y, B and R are the copper foils' representation . . . . .	21
3.3	First setup - raw data chart . . . . .	22
3.4	Material layers for capacitive sensor . . . . .	23
3.5	Second setup - data chart . . . . .	24
3.6	Second setup - data chart . . . . .	24
3.7	Experiment with plastic strips . . . . .	26
3.8	Flow sensor outside the flute . . . . .	26
3.9	Flow sensor inside and outside data . . . . .	28
3.10	Spectrum of a flute tone . . . . .	30

---

3.11	Data acquired using the Patch in pure data . . . . .	31
3.12	Spectrum of a flute tone . . . . .	32
3.13	System Diagram . . . . .	33
3.14	Software: Lip plate image . . . . .	35
3.15	Software: Jet bandwidth . . . . .	35
3.16	Software: Jet Direction . . . . .	36
3.17	Four sections of the interface . . . . .	37
3.18	Decision rules to judge lip hole shape . . . . .	38
3.19	Decision rules to judge air jet direction . . . . .	39
3.20	Version 2: Lip hole Shape section . . . . .	40
3.21	Version 2: Jet Direction section . . . . .	41
3.22	Version 2: Frequency section . . . . .	41
3.23	Version 3: Lip placement . . . . .	42
3.24	Version 3: Jet direction . . . . .	42
3.25	Version 3: Jet direction colors . . . . .	43
3.26	Version 3: Lip hole shape . . . . .	44
3.27	Version 3: Frequency . . . . .	46
4.1	Results of usability questionnaire answered by experts . . . . .	52
4.2	First iteration with beginners . . . . .	53
4.3	Questionnaire results from first iteration . . . . .	56
4.4	Second iteration interface . . . . .	57

---

4.5	Questionnaire results from second iteration with beginners . . . . .	66
A.1	Flow Sensor Setup . . . . .	74
A.2	The augmented flute schematic . . . . .	75
B.1	PureData patch schematic . . . . .	78





## List of Tables

2.1	Physical aspects that influence in the embouchure described by Putnik [1970] . . . . .	9
3.1	Common errors found from video observation	18
3.2	SNR values from setup 1, 2 and 3. The sensors are named from top to bottom of their positions on the lip plate . . . . .	22
3.3	Boundaries of <i>Green</i> state (proper lip placement) - First design. Y, B and R are the capacitive foil sensors . . . . .	34
3.4	The upper and lower bounds are the limits of playing well. Y, B and R are the capacitive foil sensors . . . . .	37
4.1	Observations of the Lip Placement section coded in 6 statements . . . . .	59
4.2	Observations of the <i>Jet Direction</i> section coded with 6 statements . . . . .	61
4.3	Observations of the <i>Lip Hole Shape</i> section within 6 statements . . . . .	62
4.4	Observations of the <i>Frequency</i> section coded with 6 statements . . . . .	63

4.5	Mann-Whitney U test - Ranks . . . . .	67
4.6	Mann-Whitney U test - Test statistics . . . . .	67

# Abstract

Learning to play the transverse flute is not an easy task, at least not for everyone. Since the flute is not a resonator on its own, the player must provide a steady focused stream of air that will cause the flute to resonate and therefore produce sound. In order to achieve this, the player has to be aware of the embouchure position to generate an adequate air jet. For a beginner, this can be a difficult task due to the lack of visual cues or indicators of the air jet and lips position. This study attempts to address this problem by presenting an augmented flute that can make the gestures related to the embouchure visible and measurable. The augmented flute shows information about the area covered by the lower lip, estimates the lip hole shape based on noise analysis, and it shows graphically the air jet direction. Additionally, the augmented flute provides directional and continuous feedback in real time, based on data acquired by experienced flutists. This work conducted three user studies. The first one was conducted with experienced flutists in order to collect comments and data. The second and third user study were oriented towards the application usability for beginners. While in the second study, the application gave a binary feedback, the subsequent version provided continuous feedback to the player. Finally, after comparing both versions, we found that the second version of the augmented flute application was more informative for the beginner. The augmented flute was designed with low cost hardware and can be expanded for further pedagogical and learning purposes or as musical interface.



# Acknowledgements

My sincere thanks to Prof. Dr. Jan Borchers and Florian Heller, for their constructive advice and for giving me the opportunity to join to the chair as a thesis student. I would like to offer my special thanks to Nur and Chat, who offered their time to test my project and gave me invaluable feedback. I wish to acknowledge the help provided by all the students and staff who work at the chair, especially to Jan Thar, who assisted me in the Fablab facilities and provided valuable suggestions on electronic sensors.

Moreover, all the advice given by flute instructors, Andre Moskowitz and Gaby Sous, was fundamental towards the development of the prototype. My heartfelt gratitude to my friends, participants, proofreaders and everyone who supported in some way to this project.

Finally, I wish to thank to David Jurado who supported and encouraged throughout this time, and to my sister Meining Cheung, for her patient guidance and important observations, honoris causa editor of this work. Huge thanks Sis :).

Thank you!



# Conventions

Throughout this thesis we use the following conventions.

## *Text conventions*

The whole thesis is written in American English.

Pseudo code functions are written in typewriter-style text.

```
function(a,b)
```

Pseudo code comments are written in typewriter-style text.

```
// this is a comment
```

In Chapter 4, we use  $p$  as a abbreviation of probability.





# Chapter 1

## Introduction

*“ The flute is the easiest instrument to play  
badly ”*

— *Leonardo de Lorenzo*

The transverse flute is considered one of the easiest instruments to play; however, this reputation is not well deserved because the playing depends mostly on the player than on the instrument. It is not like other musical instruments where hitting a key, or moving a bow over a string produces sound instantly. Moreover, mastering this instrument takes many years in order to get a clear and beautiful sound. Therefore, the learning path can be tough and in some cases a tedious process.

Playing flute mostly depends on the player rather than on the instrument

Playing the flute is a very complex process where all parts of the body are involved. The way that a player stands and breathes is very important for sound quality, long notes and player's stamina. However, to develop a good embouchure is perhaps one of the most important aspects of playing flute. Embouchure is defined as “the manner in which the lips and tongue are applied to such a mouth piece” (Dic [2015]). Moyses highlighted this, saying that the quality of a tone depends on the position of the lips and air jet strength and speed (Moyse [1946]). Fingering and articulation are also key points that a flute player develops in the long term. Thus, for a beginner, dealing with all this information can

A good body posture is needed but most important is to have a proper embouchure

be overwhelming. The aim of this work is to focus on embouchure gestures, one of the first milestones on learning flute for beginners.

## 1.1 Motivation

Appropriate embouchure position is problematic for beginners; many aspects should be considered

Among all those aspects, the embouchure position is probably the most troublesome for some beginners. A good embouchure requires flexibility of the lips, an adequate air jet and a good placement of the lips on the flute. However, it is difficult for a beginner to find the correct spot and at the same time, adopt and maintain a good embouchure position.

Common errors from beginners are related to lip placement, lip hole shape and air jet due to the lack of visualization

Common errors on beginners' embouchure are related to how they place their lips on the flute. Some beginners students have the idea that they should blow directly inside the flute. This is wrong, due to the fact that the flute does not have a resonator inside like a recorder or other wind instruments that can generate the vibrations (sound waves). Another common error is that not enough of the lower lip is used to cover the embouchure hole of the flute. The problem in beginners is that they are unaware of this, for two reasons. The first one is because they are not used to feel the edge of the embouchure hole, and second, it is hard to check this by themselves, even with a mirror (unless there is a mirror that can be seen without turning, above the player). In this case, a teacher is very valuable, since he or she can observe the student's performance, while keeping permanent observation is not practical. The shape of the lip hole is another problematic aspect for beginners because of the difficulty to determine visually with accuracy the shape of the lip hole, as well as the embouchure hole covered area by the lower lip. Air jet direction can be problematic, but it is relatively easier to check. Teachers usually indicate the students where to blow using their hands, as to feel the air direction. There are educational tools also available, which are installed on the flute to indicate this, but it is difficult for the student himself to assess this without some help.

Beginners are not aware of their problems, this leads to frustration

Therefore, the problem of being able to see what the begin-

ner is doing, is always present during their initial attempts to learn flute. Tasks become difficult when there are no visual cues of what is being performed. This might lead to frustration, especially when there is no sound coming out of the flute.

On the market, there are several tools that can support beginners while learning flute, but none provide continuous and directional feedback as the augmented flute.

Few tools to support flute learning

## 1.2 Contribution

This study tries to alleviate beginners' problems by making measurable and visible the gestures related to the embouchure: area covered by the lips, shape of the lip hole and the amount of air jet inside and outside the flute. In order to do that, we developed an augmented flute that acquires data from the player and makes embouchure problems visible through a real time application. Additionally, it provides feedback according to the data acquired.

The augmented flute makes visible and measurable embouchure gestures

The design of the augmented flute adds sensors in strategic positions according to technique principles and physics of the instrument. The augmented flute and the application are not meant to replace the flute teacher, but to be a supporting tool that can be useful for both, beginners and flute teachers.

The design took in consideration the flute technique and physical aspects

In this study, we also performed experiments with experienced flutists as well as beginners. The tests results indicated that the augmented flute can be of benefit for beginners.

This study found that the augmented flute can be beneficial for beginners

## 1.3 Outline

This work is divided in five chapters:

Outline of this work

- In this chapter, we described the motivation for this

work and contribution.

- Chapter 2 “Background and Related Work” introduces flute technique methods and physics of the instrument. Additionally, an overview of similar augmented flutes and related work is given.
- Chapter 3 “Design and Implementation” reports observations of flute video classes. Also, it describes the hardware and software prototypes of the augmented flute. The software prototype has 3 iterations; each design is detailed here.
- Chapter 4 “Evaluation” shows the usability evaluation and results. We test the augmented flute first with experienced players and then with beginners. Additionally, we perform another experiment with beginners taking into account the comments of the first group.
- Finally, in Chapter 5 “Summary and recommendations” we describe the limitations of this work and recommendations for future work regarding design of the prototype and future applications.

## Chapter 2

# Background and Related Work

In order to give proper direction and support to beginners, it is important to know about flute technique and the physical aspects that are involved. This chapter will introduce a brief summary of flute methods that describe how to build a good embouchure. Subsequently, the physics involved in the flute produced by the embouchure will be described. At the end of this chapter, we will review other augmented flutes designed to extend musical expression and discuss some of the existing learning tools that support flute players.

This chapter introduces some flute methods, physical aspects and other augmented flutes

### 2.1 Flute Methods for a good embouchure

The transverse flute is composed of three parts: head joint, body joint and foot joint. The head joint contains the lip plate where the embouchure is placed (Fig. 2.1). The body as well as the foot joint contains the mechanism to cover the key holes to produce a particular tone.

Parts of a transverse flute

This work will focus on the head joint since it holds a principal role in tone production. In this section, we selected some methodologies from flute literature that will help us

Our focus will be on the head joint

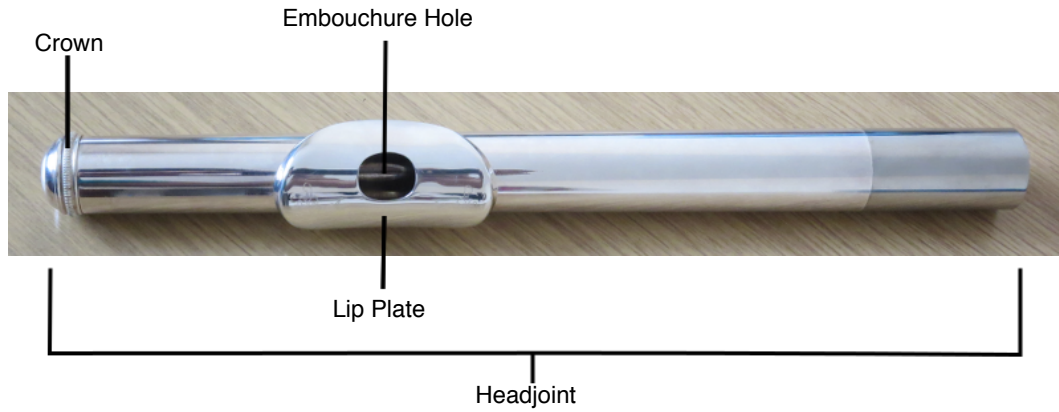

**Figure 2.1:** Head joint of the flute

describe how to obtain a good embouchure.

### 2.1.1 Embouchure preparation

Embouchure  
preparation by Arthur  
Brooke

Arthur Brooke described in his book [Brooke, 1912] how to prepare the lips position in two steps. The first step is the relaxation of the muscles of the mouth, followed by the second step, which is dragging the lips towards the corners of the mouth. We illustrated those two steps, *a* and *b* respectively in Figure 2.2. In addition, we added a third step (Fig. 2.2) which shows the so-called “lip hole” created by letting the air go through the lips. The shape of the lip hole according to Brooke has to have a longitudinal form; a round shape should be avoided.

### 2.1.2 Embouchure placement and blowing

Lip placement by  
Henry Altès method

Altès [1897] described in his book “Method for the Boehm Flute”, how the lips should be placed on the lip plate: “*The embouchure (mouthpiece) must be placed against the edge of the lower lip where the red part of the latter begins.*”—Altès [1897]. This is illustrated in Figure 2.3. Also, Altès recommended



**Figure 2.2:** Embouchure position: a) relax position, b)dragging lips towards the corners and c)lip hole

covering, with the lower lip, one-fourth of the embouchure hole. Other methods like Takahashi [1999] stated that the lower lip should cover about half of the embouchure hole. Regardless of whether the lip covers one fourth, or half of the hole, more than half will produce a dull tone (Putnik [1970]).

Lower lip should cover about half or one-fourth of the embouchure hole

From here, we will use the term “embouchure” to refer to the player’s lips and mouth position with respect to the lip plate of the flute and “embouchure hole” to the hole of the lip plate as in Figure 2.1).

Blowing into the flute hole has two main aspects: air stream and air jet angle. *Air stream* is the air that comes from the lungs and flows between the lips. *Air jet angle* is the angle produced by the direction of that air. We will use the term “air jet” and “jet angle” to refer to the air stream and its angle respectively.

Air jet and jet angle are important in the blowing technique

The flute should be held in parallel to the line formed by the lips and the air jet centered to the far edge of the embouchure hole. Then, the air jet will hit the edge and a sound will come. A few adjustments can be done by turning the flute in or out to discover the best sound [Putnik, 1970].

Exploring a best tone by turning in/out the flute

### 2.1.3 Embouchure problems

Putnik [1970] said that the problem in beginners’ embouchure lies generally in the lack of muscular control of the embouchure and the physical characteristics of the lips.

Embouchure problems: lack of control of mouth muscles and lips morphology



**Figure 2.3:** The fleshy part of the lower lip should touch the lower edge of the embouchure hole

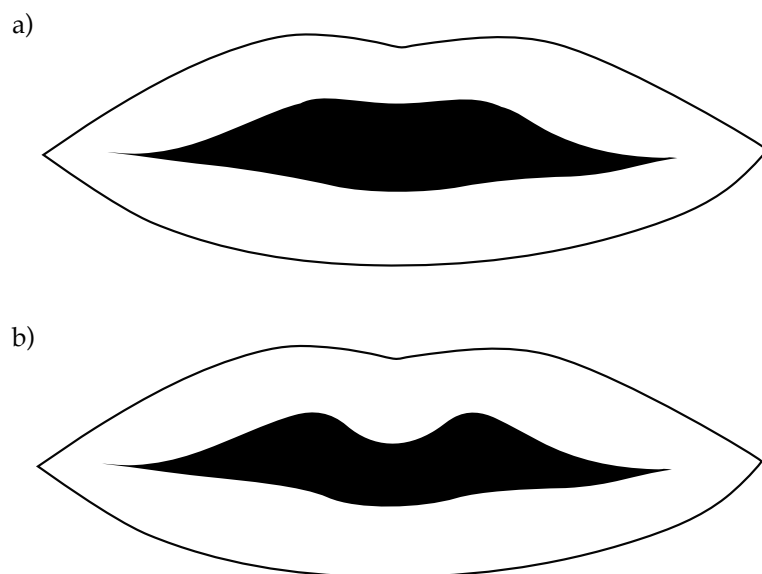

**Figure 2.4:** a) Upper lip without a split b) Split embouchure - The upper lip with a prominent center

However, this can be solved by adapting a player's physical constraints to a proper position. In his methodology, he described some of these problems. Here, we summarized them in Table 2.1.

Blowing using the cheeks is another error

Wagner [1918] remarked that a common error for starters was to puff out their cheeks, which produces loss of lips control. This action resembles the act of using the cheeks to pump up a balloon.

Adjectives frequently used due to a non-clean tone be-



Physical aspect	Possible result	Propose solution
A thick upper lip	Air jet direction is directed too low into the embouchure hole	Tighten the upper lip by drawing back or down the corners of the mouth and/or bring the jaw forward
A thin upper lip	Air jet angle is too little	Tighten the lower lip by drawing up the corners of the mouth and bring the jaw back
Shape of the upper lip "split embouchure" (Fig. 2.4)	Air jet is split	Close one of the splits and move the lower lip in the direction to match the aperture in the upper lip
Irregular lip shape	Air jet could be center-off	Move the lower lip in the direction to obtain a better lip hole shape
Too much covering of the embouchure hole	The tone is small	Rotate the flute until the lower edge of the embouchure hole match the lower lip
Covering too little the embouchure hole	The tone is shallow	Turn the flute slightly backwards and/or pull the jaw back
Windy tone	Air jet is not well-centered or irregular lip hole shape	With the help of an instructor, correct the lip hole shape and center it

**Table 2.1:** Physical aspects that influence in the embouchure described by Putnik [1970]

cause of embouchure problems are "breathy", "fuzzy" or "windy". For Brooke [1912], the tone is "breathy" when the upper lip is too forward with regard to the lower lip and "fuzzy" when the lower lip is too forward. Putnik associates "breathy" when the lip hole is too big or the air jet angle is too small. Also, he defines a "windy" tone, when the air jet hits the sides of the embouchure hole produced by an irregular lip hole shape or off-centered air jet .

Terms like breathy, fuzzy, windy denote a non-clean tone

Problems related to switching between octaves will not be mentioned here. We will be focusing on the typical tone produced (around 880 Hz) only by using the head joint of the flute.

## 2.2 Physics of the flute head joint

Modern flute follows  
Boehm's design

The physical characteristics of the flute have changed over time due to the necessity to improve tone quality, expand tone register and ease key fingering combination. Current flute models follow Boehm's heritage of 1847. The transverse flute is almost cylindrical with the exception of the head joint. The cylindrical bore is around  $19\text{mm}$  of diameter (for the body joint and foot joint) but, for the head joint, the diameter becomes slightly reduced towards the embouchure hole around  $17\text{mm}$  [Fletcher and Rossing, 2012].

The standard shape for the embouchure hole is the one proposed by Boehm, which has a rectangular shape about  $10\text{mm}$  by  $12\text{mm}$ . However, elliptical shapes exist in early flutes. The lip plate is located over a conduct of  $5\text{mm}$  height. The embouchure hole shape forms this conduct. The key mechanism and finger holes attributes are also based on Boehm's design (Boehm et al. [2011]), but it will not be described here, since it is not relevant for this study.

### 2.2.1 Sound production

The air jet deflection  
on the embouchure  
edge produces  
standing waves that  
makes flute sound

The process in which the flute emits sound is summarized as follows: the air jet produced by the player hits the edge of the embouchure hole and is deflected into and out of the hole. This deflection pushes the air already inside the flute, and at the same time the pipe vibration feeds the jet alternation of going in and out the hole. Thus, the vibration excites the air inside the pipe and makes it work as an open pipe in both ends. As a result standing waves are produced that go along the pipe. This forms regions with high and low pressure. The regions with low pressure let the air molecules displace along the pipe, while the air molecules within high pressure regions are not able to move at all. The points with the highest displacement are called *pressure nodes* and the points with lowest displacement are called *pressure antinode* [Gilbert, 2012].

Pressure Nodes are  
located on regions  
with low pressure

The Figure 2.5 illustrates a compression pulse represented

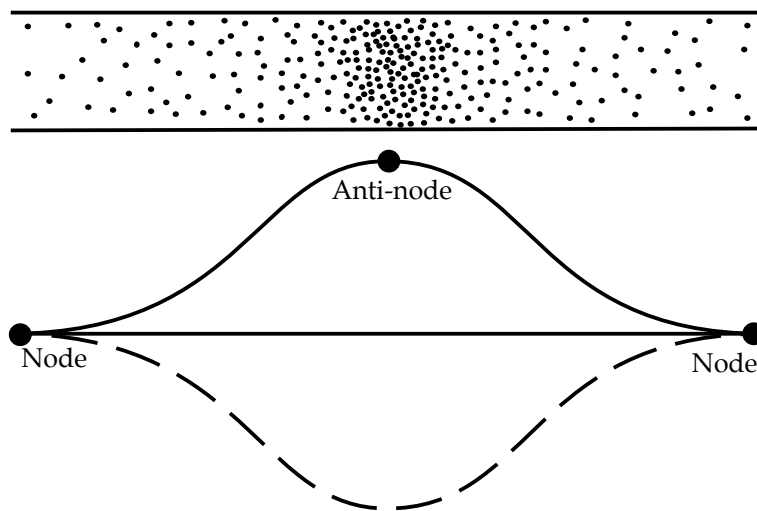

**Figure 2.5:** Standing wave inside an open pipe of both ends

by open pipe of both ends with a standing wave curve. The upper part shows the pipe with air molecules inside. The lower part shows a curve that represents the standing wave (Pressure vs Position). Pressure nodes are located at the ends as they are able to escape from the pipe (low pressure). A pressure anti-node is located in the middle due to the high density of air molecules accumulated, which does not let them move freely (high pressure). Many pulses of compressions are sent continuously because of the air jet vibration. When one pulse reaches the end, a low pressure is reflected to the other direction (dashed curve).

As mentioned previously, there are pressure nodes at both ends of the pipe since the air molecules are exposed to the outside. This is called *boundary conditions* that must be fulfilled to resonate frequencies into the instrument. This indicates which other frequencies could occur in the pipe. For example, the lowest frequency has the shape of half the sine wave (similar to the wave in Figure 2.5). It meets this condition having two pressure nodes at both ends. This frequency is called *fundamental* frequency and its multiples are called *harmonics*. Increasing the air jet speed increases the number of compressions. This allows to reach higher harmonics with higher frequencies as well.

Pressure Anti-nodes are located on regions with high pressure

Boundary condition specifies two pressure nodes at both ends

Frequencies that follow the boundary conditions are the fundamental and its harmonics

The equation to calculate any frequency is:

$$f = \frac{v}{\lambda} \quad (2.1)$$

$v$  is the speed of the sound which is 344 m/s at 20°C and  $\lambda$  is the wavelength. To calculate the fundamental frequency, the wavelength  $\lambda$  is twice the length of the pipe. This is because it travels forward and backwards (it goes forward with a positive pressure and backwards with a negative pressure) the length of the pipe (as Fig. 2.5). Then Eq. 2.1 becomes:

$$f_0 = \frac{v}{2L} \quad (2.2)$$

The harmonics are just multiples of the fundamental  $f_1 = 2f_0$ ,  $f_2 = 3f_0$  and so on.

Benade and French [1965] presented a complete study of the head joint of the flute including the tuning effect produced by the taper (cork in the crown of the head-joint).

## 2.2.2 Embouchure gestures effects in produced sound

Embouchure gestures  
involve physical  
aspects

Until now, we have seen how the flute resonates, produced by a player's air jet. However, the embouchure gestures of the player on the instrument involve physical aspects. Moyses [1946] mentioned that the lip position, speed, and strength of the air jet are parameters that define tone quality. Also, Fletcher [1975] measured other aspects like: blowing pressure, jet length and jet cross section (lip hole shape). He found correlation between his results and flute technique. We will describe some of these aspects in this section.

Increasing the  
embouchure hole  
covering rises the jet  
velocity  
The embouchure  
hole covering is  
highly related to the  
jet length

*Embouchure hole covering* — Coltman and Fletcher studied the embouchure hole covering in different ways. Coltman [1966] measured the area not covered of the embouchure hole and he found that by reducing this gap, it was easier to produce higher frequencies because of the jet velocity. Fletcher [1975] studied this gesture by measuring the

jet length. He stated that the embouchure hole covering is closely related to the jet length (about 1-2 mm less). The jet length was measured from the lip hole to the edge of the embouchure hole. His results agreed with Colman's results. Additionally, Fletcher defined a relation between the frequency  $f$  and the jet length  $l$ :

$$l \approx 0,14f^{-1/2} \quad (2.3)$$

Fletcher [1974] also stated that in order to play the fundamental frequency, it requires an appropriate jet length and jet velocity. These parameters influence the travel time of the wave to reach the end of the tube. If the travel time is less than the half of the fundamental frequency, there will be no sound. On the other hand, if the travel time is greater, an upper octave will be produced.

The jet length and its velocity affects the travel time of the standing wave

*Jet angle and blowing pressure*— Jet angle is another parameter that affects the frequency of a tone. Fletcher [1975] showed through photographs that air jet angle is normally located between 25-40 degrees and shallower angles can help produce low notes. Also he studied the air jet through blowing pressure inside of the mouth. In this study, he observed a linear behavior when increasing the blowing pressure to produce higher notes.

Jet angle affects the tuning

Higher blowing pressure can produce harmonics

*Lip hole shape*— Fletcher [1974] stated that a good player should avoid to have a lip hole bigger than the embouchure hole width, nor a height more than 1.3 mm. A wider lip hole can lead to a breathy noise, which produces a waste of air. On the other hand, a thicker jet decreases the harmonic development. Thus, a thinner lip hole is ideal to produce a tone rich in harmonics.

Ideal lip hole shape should be thinner and no wider than the embouchure hole

Turning the flute in, having a steeper jet angle, or lowering the chin, can make the tone sharp. Turning the flute out, blowing across, or raising the chin can produce a sharp tone. The same effect could be reached by changing the area uncovered of the embouchure hole [Fletcher, 1974].

Different methods to produce a sharp/flat tone

## 2.3 Augmented Instruments

Augmented instruments by using technology

Augmented instruments are known as extended instruments, which are acoustic instruments with extended features by adding sensors or other kind of technology (Wanderley and Depalle [2004], Siwiak et al. [2014]). The extension of a musical instrument opens a door to many possible applications. Two main threads have been developed widely [2004]: converting a gesture to sound (e.g. "Hyperinstruments" [Machover, 1992], instrument-like controllers [Yunik et al., 1985]) or gesture analysis produced by the interaction of the musician with its instrument. The bridge between sensor limitations and control of a musical aspect is often challenging. Wanderley, in his work (Wanderley and Depalle [2004]), surveyed the considerations for the augmentation design in musical context: how the gesture will be acquired and what kind of feedback or controller will be provided.

Bridge between technology and parameters is difficult

### 2.3.1 Augmented Flutes and learning environments

Virtually real flute synthesizes sounds considering airflow and fingering as inputs

Ystad and Voinier [2001] proposed a *virtually real flute*, an augmented flute that synthesizes the physical aspects and produced sound of the acoustic flute. They used sensors to feed a synthesis model. The cork of the head-joint was removed and a microphone was placed instead in order to measure the air pressure inside the flute. Magnetic sensors were added to the keypads of the flute to detect finger position. Also, they used filters to simulate wave propagation and thus add effects on the output sound.

Hyper-Flute behaves as an acoustic flute and it uses sensors to add special effects

The Hyper-flute by Palacio-Quintin [2003] added sensors to the flute without compromising the original acoustic of the instrument and technique. Thus, the placements of the sensors were strategically located, e.g. pressure sensors were located on points where the flute was being held. The goal was to gather data (from the sensors) in real time and map them to control digital sound parameters. However, they observed the difficulty of playing while controlling

other parameters. Therefore, a new version was under development [Palacio-Quintin, 2008].

Another augmented flute was proposed by Da Silva et al. [2005]. They measured the airflow velocity in two points (one to the left and one to the right) on the mouthpiece using two stagnation tubes from a pitot tube. The aim of this study was to be able to control a flanger effect by sweeping the frequency up and down. The frequency swept up when the jet was directed to one of the sensors, while the other swept it down. There are other works that, according to the classification of Wanderley and Depalle [2004], are instrument-like controllers, for example, Yunik et al. [1985], Scavone [2003], [Yamaha WX<sup>1</sup>](http://usa.yamaha.com/products/music-production/midi-controllers/wx5/) series among others. Those instruments can synthesize flute sounds taking into account air pressure and fingering, however they do not follow Boehm's design.

Augmented flute controls a flanger effect with airflow detection as inputs

There are some related work that use augmentation to assist learning especially for transverse flute. Siwiak et al. [2014] published a paper where they stated the limited use of technology for flute pedagogy or for it to provide feedback to musicians. One of these few works is, the tool proposed by Rincon L. and Galeano R. [2011]. Although the proposed work involved a recorder, the use of technology to assist learning is important to mention. The recorder had sensors as inputs and the data sensed was sent to an application. Then, it provided feedback accordingly to assist the student. The feedback addressed air pressure and fingering. The application also combined theory and practice. A different alternative was the use of anthropomorphic robots to assist flute learning, presented by Solis et al. [2004]. In this work, a robot provided visual and verbal feedback to flute beginners after an offline analysis of the audio recordings regarding harmonic structure and other features; however, this research work did not involve any augmentation of the flute. A noticeable learning tool which does not use hardware is the Blocki flute method Blocki and Blocki [2002]. This method is important because it employs a special head joint that provides a mechanical visualization of the airflow. The head joint is made of plastic and has four small fans located in a row in front of the embouchure

Limited use of technology to assist flute learning

Electric recorder to assist learning

Robots assistants

Blocki flute method

<sup>1</sup><http://usa.yamaha.com/products/music-production/midi-controllers/wx5/>

hole that indicates the direction of the airflow. However, it does not produce any sound because of the open cut in the embouchure hole.

If anything can be deduced from the previous related work, is the repeated attempts to give visual feedback, and improve the learning stage. Now, the use of sensors and other electronic measurement devices, and the use of software can be combined and give tangible and visual results, using the instrument itself. The design and implementation will be described in the following chapter.



## Chapter 3

# Design and Implementation

Previously, we explained how the flute produces sound and the basics of a good embouchure technique. That knowledge will be the foundation for this project. The aim is to produce a visual representation of the embouchure to provide learning support for beginners. In this chapter some ideas gathered from our observations will be shown. The augmented flute prototype has two parts: hardware and software prototype.

### 3.1 Observations

We randomly selected six videos from the web to observe typical problems in beginners, who started learning flute, and the instructions given to address those problems. The videos belong to: (Chung and Chen [2013], Bugner [2014], McClanahan [2014], Watts [2013], Yerkey [2014], and Grove [2014]). The instructors are young flutists giving instructions to beginners. All of them gave an introduction on how to play flute and how to assemble the instrument. The summary of the embouchure corrections made by the instructors can be found in Table 3.1. The “piu” exercise in Table 3.1 consisted of pronouncing the syllable “piu” to have a

Six videos were observed

“piu” exercise to adjust the lip hole shape

reference on how the lip hole shape should be.

<b>Mistake</b>	<b>Correction</b>
Lower lip position	Instructor manually adjusted
Wrong air jet angle	Instructor advised to place his or her hand at the angle indicated to feel the air and to be aware of the angle
Small amount of air	Verbally advised
Matching the lip hole with the embouchure hole	Instructor manually adjusted with a verbal advice
Wrong lip hole shape	Verbally advised. An instructor applied "piu" exercise
Tilted head-joint	Instructor manually corrected
Cheeks were pumped off	Non-corrected

**Table 3.1:** Common errors found from video observation

Five of six beginners produced sound; three had difficulty

One of the six beginners failed to produce sound. Three of them could do it, but they had trouble reproducing it again, two could play a consistent sound more frequently, and one of the beginners pumped her cheeks without being corrected.

Three problematic aspects: lower lip covering, air jet angle and power, and lip hole shape

From these observations, we could distinguish 5 problematic aspects: lips position, air jet power and angle, lip hole shape, cheeks position and flute holding. From these aspects we defined three parameters to measure. These parameters are: lower lip covering, air jet (angle and power) and lip hole shape. This work will focus on these parameters that are harder to identify. This way, the visual representation of these parameters will provide information that they did not possess before to help students and instructors locate any problems in the embouchure. Cheeks position and flute holding can be observed and are easily corrected by the instructor.

Two flute teachers were interviewed

To support our observations, we interviewed two flute instructors about the parameters and the hardware prototype in construction. They agreed with the proposed content and provided useful information to improve the prototype.

## 3.2 Hardware prototyping

The prototype covers three embouchure parameters: lip covering, air jet (power and angle) and lip hole shape. It was considered that the augmentation of the flute should be inexpensive, as simple and easy as possible and that it should maintain (as possible) the acoustical characteristics of the flute.

Requirements of the flute augmentation

The sensors selected are relatively small and lightweight. The sensors employed for each parameter were:

Each sensor sensed a parameter

- Lip covering - Capacitive sensors on the lip plate
- Air jet angle and power - Two airflow sensors. One inside the flute and one outside
- Lip hole shape - Audio acquisition by a external microphone for real time audio processing

We used capacitive sensors for a direct acquisition of the gesture. We used flow sensors for a direct acquisition as well of the air jet. For the lip hole shape, we applied a real time audio processing for an indirect acquisition of the gesture. Each parameter will be explained in the following sections (3.2.1, 3.2.2 and 3.2.3).

Lip covering and air jet were acquired directly. Lip hole shape was estimated by indirect acquisition

We employed an [ATmega32u4](#)<sup>1</sup> (Arduino Leonardo) micro controller for the hardware prototype. It provides a differential amplifier feature that we found useful to add more resolution to the air jet sensor values.

The augmentation used an Arduino microcontroller

### 3.2.1 Sensing the lip covering

We used capacitive sensors to measure the lip covering on the lip plate. A capacitive sensor is a conductor that detects anything that is conductive or has a dielectric constant different from air [Wang, 2014]. The system can be seen as

Strips of copper foil were placed over the lip plate

<sup>1</sup>Arduino Leonardo datasheet

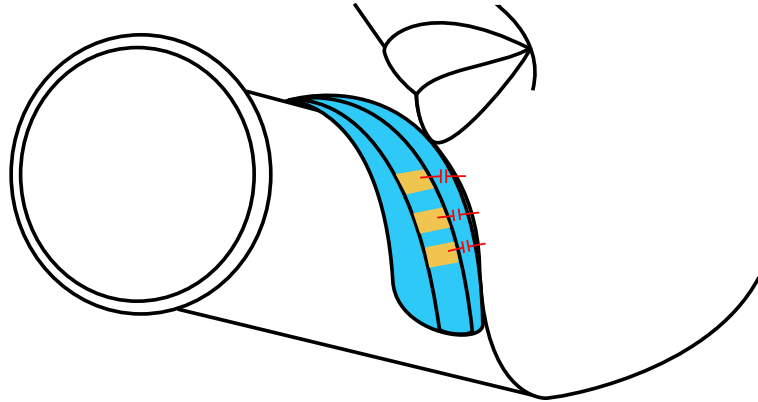

**Figure 3.1:** Capacitance between the copper foils and the player's chin

Covering area in terms of capacitance

a parallel capacitor between the player and the flute (see Fig. 3.1). We placed the strips of copper foil over the lip plate, and they were mostly equally spaced. They act as conductive sensors to acquire data. The idea was to be able to detect covering on the whole lip plate area. The sensors measure the capacitance through arbitrary time units as duration to charge the copper foil. During this time the charge is distributed over the foil and a counter is accumulated until the foil is saturated.

Unwanted capacitances affects the system

There are other unwanted capacitances called parasitic capacitances, which add noise to the system. Therefore, we used the signal to noise ratio (SNR) to determine the stability of our system with the following formula [Davison, 2012]:

$$SNR = \frac{|\mu_u - \mu_p|}{\sigma} \quad (3.1)$$

$\mu_u$  = mean value when not playing

$\mu_p$  = mean value when playing

$\sigma$  = standard deviation of the signal

According to the report for Touch Sensors by Davison [2012], a SNR of 7 is at least required.

Three different foil placements were tested

We made three different placements of the foils. Figure 3.2

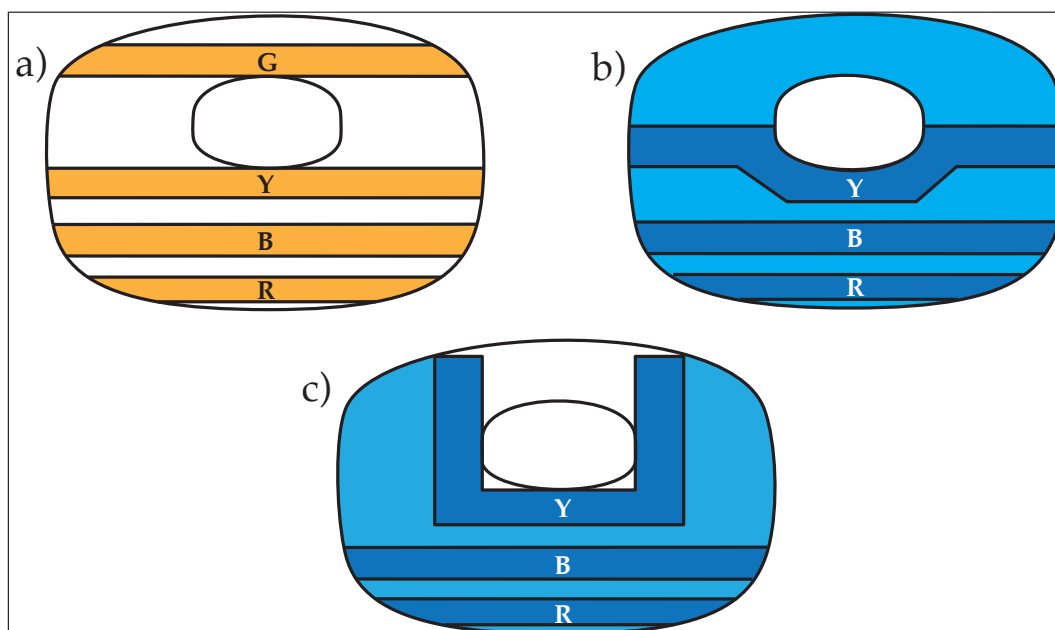

**Figure 3.2:** Sensors placement: a) First setup, b) Second setup, c) Final setup

shows all three versions with the foils' placement.

The first setup consisted of four copper foils (see Figure 3.2.a). Three of them (*Y*, *B*, *R*) were located on the lip plate in order to sense the lower lip covering. The fourth foil (*G*) was placed above of the embouchure hole to sense the upper lip. The strips had a width of  $4\text{mm}$ , and the spacing in-between strips was about  $4\text{mm}$  (with the exception of the upper foil). The foils *G*, *Y*, *B* and *R* had a length of  $4.5\text{cm}$ ,  $5\text{cm}$ ,  $4.5\text{cm}$  and  $3\text{mm}$  from top to bottom respectively.

First version tried to detect upper lip and lower lip

The strips were not placed on the lip plate directly, instead a layer of paper was placed first, then the strips, and finally a cover of transparent tape. The paper layer acted as an insulator between the foils from the metal of the flute. This is important to avoid expansion of the charging area over the flute. For this reason the flute was connected to ground.

The foils were insulated

We calculated SNR values for the first configuration and we found instability for sensor *G* (see Table 3.2). This could have been produced by the steam originated from the air jet that hit that particular zone, resulting in inconsistent data.

Sensor *G* was very noisy

SNR values			
Sensor	Setup 1	Setup 2	Setup 3
G	0.14	—	—
Y	17.31	65.31	482.82
B	16.26	90.38	251.46
R	5.31	91.3	33.54

**Table 3.2:** SNR values from setup 1, 2 and 3. The sensors are named from top to bottom of their positions on the lip plate

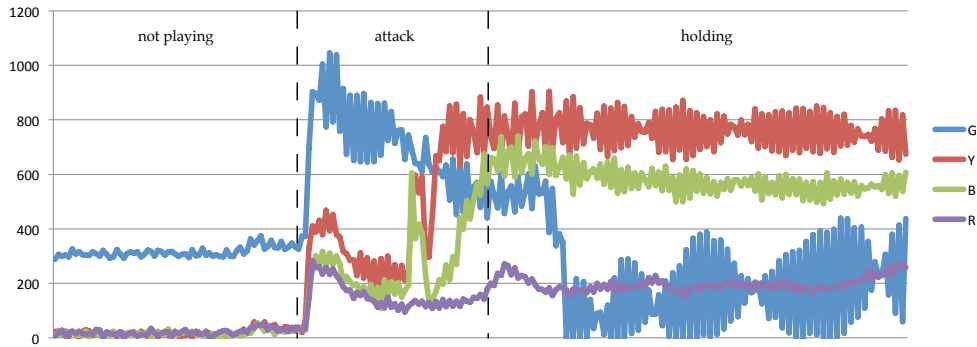

**Figure 3.3:** Raw data acquired from the first setup while playing a tone by an inexperienced flutist. Y axis shows capacitance values in arbitrary time units

Therefore, this region was discarded in the following designs.

Figure 3.3 shows the raw data obtained from this setup. It had three states: *not playing*, *attack* and *holding*. *Not playing* state referred to the absence of lip detection on the sensors, *Attack* state, when the lips are placed and a tone was produced but not stable, and *Holding*, when a tone was stable. The data shows *G* with an abnormal drop in the *Holding* state, this behavior could possibly be a charge leak due to its placement that exposes the sensor to the air jet steam.

Second configuration, *Y* borders the half of the embouchure hole

In the second configuration, we changed the shape of the foil *Y* near to the embouchure hole (see Fig. 3.2.b). Also the length of the foils *B* and *R* were reduced, to fit better the area of the lip plate. The length changed to *5cm*, *3cm*

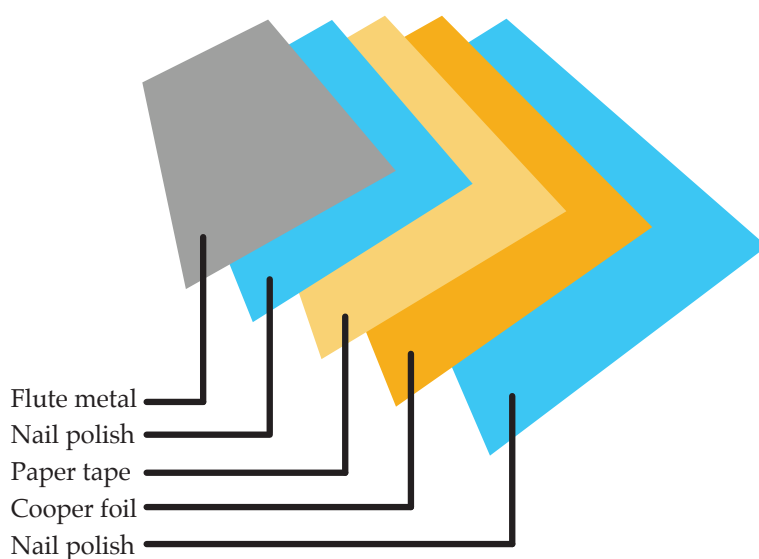

**Figure 3.4:** Material layers for capacitive sensor

and  $2\text{cm}$  for  $Y$ ,  $B$  and  $R$  respectively. We moved the sensor  $Y$  towards half of the embouchure hole and surrounded the hole with diagonal borders. The idea was to improve the detection when the hole was covered more than half. We used nail polish to replace the transparent tape. As nail polish is a polymer, it worked as an insulator and glued the sensors to the flute more firmly. Figure 3.4 shows the layers materials for setup 2 and 3. The data acquired (with a smooth filtering) using this setup is shown in Figure 3.5. It showed a better performance than the first setup. This setup had four states: not playing, attack, holding and release. The three states have the same description as in the first setup. The fourth state, *release* referred to the ending of the note played, and the removal of the lips from the flute.

In the last configuration, we changed the  $Y$  foil shape to a square U shape because we wanted to expand the detection encompassing the whole length of the hole. (see Figure 3.2.c). The  $Y$  foil had a height of  $1.7\text{cm}$  for two sides, a bottom length of  $2.5\text{cm}$ , and a width of  $5\text{mm}$ .  $B$  and  $R$  had a length of  $4.5\text{cm}$  and  $3\text{cm}$  respectively, and a width of  $4\text{mm}$ . SNR values are shown in Table 3.2 as Setup 3. The data obtained with this setup is shown in Figure 3.6. It shows that sensor  $Y$  had values around 1500 during the *not playing* and

Nail polish replaced  
by paper insulator

Third setup,  $Y$   
borders the  
embouchure hole  
with a U shape

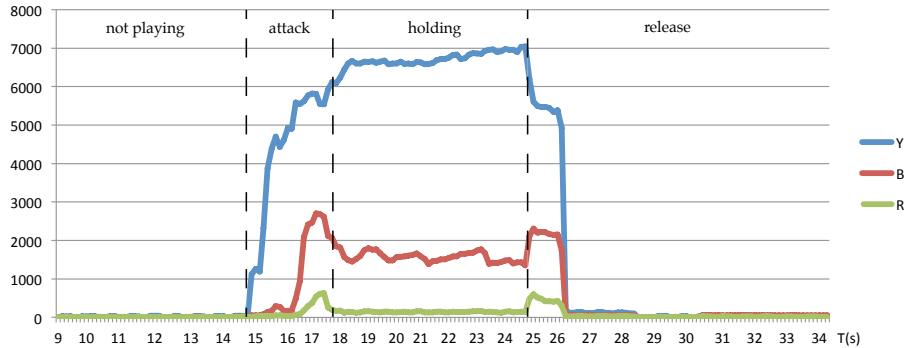

**Figure 3.5:** Data acquired from the second setup while playing a tone by an inexperienced flutist. Y axis is capacitance in arbitrary time units. X axis is actual time in seconds

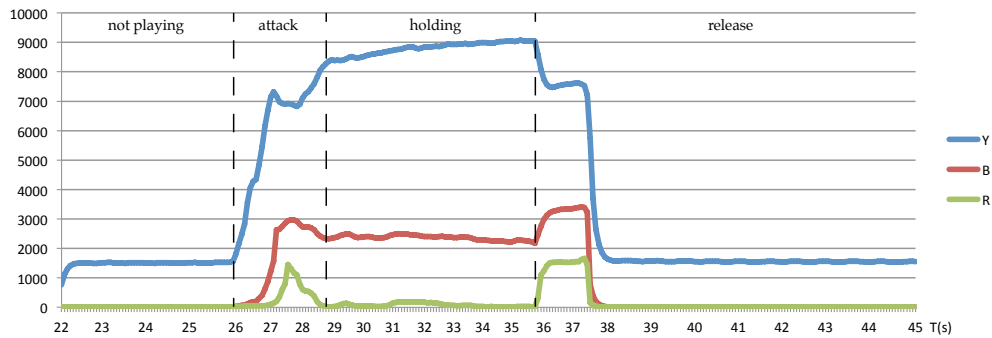

**Figure 3.6:** Data acquired from the third setup while playing a tone by an inexperienced flutist. Y axis is capacitances in arbitrary time units. X axis is actual time in seconds

*release* states. In other tests, it was observed that normally all sensors start with very low values (less than 200), possibly due to an incomplete discharge after continuous use. However, the values during *holding* state were consistent.

Setup 2 and 3 were measured in different conditions

Setup 2 and 3 were measured in different conditions. Setup 2 (as setup 1) was measured using Arduino Leonardo and setup 3 using [Arduino Micro](https://www.arduino.cc/en/Main/arduinoBoardMicro)<sup>2</sup>. Both boards are based

<sup>2</sup><https://www.arduino.cc/en/Main/arduinoBoardMicro>



on ATmega32u4 micro-controller, but Arduino Micro is smaller than Arduino Leonardo. Additionally, setup 2 was tested using a prototyping board and setup 3 using a printed circuit board.

The data acquisition was done using a library written by [Paul Badger](#)<sup>3</sup> that implements the process to measure capacitive data. The sensing values (counters) are in arbitrary units. Additionally, we used an arbitrary weight parameter of  $\alpha = 0.5$  to smooth the signal:

$$y(t) = \alpha * y(t) + (1 - \alpha) * y(t - 1) \quad (3.2)$$

During our test, we obtained 7-8 samples from the micro-controller (foil sensors) per second.

### 3.2.2 Sensing air jet

In order to produce sound with the flute, it is essential that the airflow of the player hit the far edge of the embouchure hole to produce the pulses (air goes into and out of the embouchure hole) that originate the standing waves. With this principle, we decided to place the flow sensors [fs5](#)<sup>4</sup> one inside and one outside the bore. The aim was to find the proper place when both sensors detect the air jet while playing well. For example, if only one sensor detects air, it means that the air jet is not going in the right direction.

Studying the air jet of the player outside the flute can be complicated due to the absence of boundaries. The air jet is turbulent [Da Silva et al., 2005] and thus difficult to assure that the airflow will follow a certain path. Therefore, we tried a small experiment to support that there is enough air to be detected. We attached strips of plastic bag below the lip plate (see Fig. 3.7.a). Then, we applied the Bernoulli's principle to visualize how the strip lifts up when blowing. According to this principle, when the velocity is increased, the pressure decreases, because the gas or fluid have less

Capacitive Sensing Library was used to acquire data  
Smooth filtering was employed

Two airflow sensors were placed to track the air jet

An airflow sensor outside the flute

An experiment was performed to find air jet angle using Bernoulli's principle

<sup>3</sup>Capacitive Sensing Library

<sup>4</sup><http://www.ist-usadivision.com/objects/media/data-sheets/product/flow/FS5.pdf>

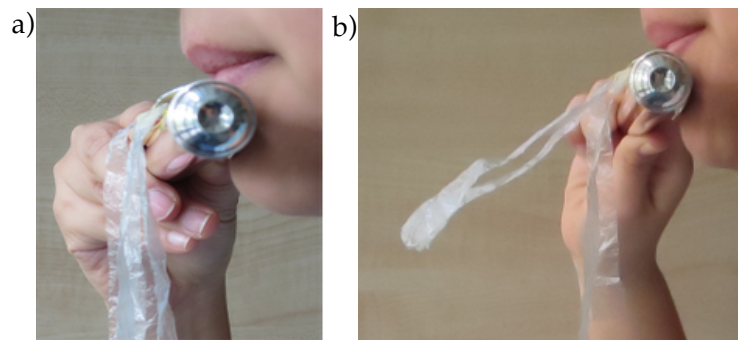

**Figure 3.7:** Plastic strips lifted by the difference of pressure.  
a) Without blowing b) Blowing

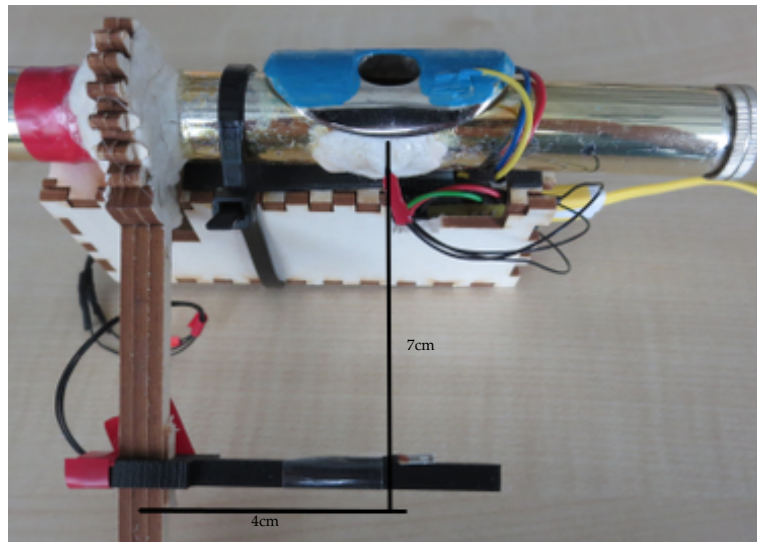

**Figure 3.8:** Position of the flow sensor outside the flute: 7cm of distance and 30 degrees from the horizontal

resistance; then, the differential of pressure is what causes the strip to lift. Figure 3.7.b shows how the strip lifts when blowing. The measured air jet angle was about 30 degrees, which agrees with [Fletcher, 1975] observations, but measured outside the flute. With this information, we located the sensor at 7cm and 30 degrees from the horizontal axis (see fig. 3.8).

An airflow sensor  
inside the flute

The second airflow sensor was placed inside the bore. For

this purpose, we drilled a hole with a diameter of  $3mm$  right below the upper edge of the lip plate ( $5mm$ ). We suspected that this would probably increase the impedance<sup>5</sup> of the airflow oscillation in the flute however; our aim was to be able to detect the air jet deflected into the flute. We tested the setup with four experienced players to obtain information about their experience playing with the sensor inside the flute. From the four subjects, only one player reported that the sound was a little different, attributing the cause to the inner sensor, but could not assure this was really the case. Nonetheless, a slight timbral change was not considered as a critical problem because the design of the prototype does not focus on the production of a high quality tone.

Inner sensor might impact flute impedance and sound quality

The augmented flute does not pursue a high quality tone

The flow sensor fs5 works with a heater and a temperature sensor. Basically, the circuit establishes a certain temperature in the heater (which depends on input voltage). When the airflow of the player passes across the sensor, the heater cools down and thus the temperature changes. The temperature is translated into voltage, which is the output signal of the sensor. The amount of voltage needed to compensate the loss of temperature was controlled by software (see appendix A). The sensor output was observed between  $0.58v$  and  $1.56v$  for an input voltage of  $0v$  and  $5v$  respectively. The output of the sensor was converted to digital using Arduino's ADC (Analog to Digital Converter). They were between 117-148 (31 different values). We wanted to amplify the range of values, therefore we made use of a differential amplifier which is a feature of Arduino Leonardo. As a result we expanded the sensor values to 511 values. The differential amplifier required specifying the upper and lower bounds to be amplified. The bounds were  $0.58v$  and  $1.56v$  obtained before. Then, Arduino Leonardo calculated the ADC value through the following formula ([ATMega32U4's datasheet](#)<sup>6</sup>):

The flow sensor fs5 had a heater and a temperature sensor

The heater's temperature changes with the player airflow

The temperature is retrieved as voltage

ADC transforms voltage to numeric values

$$ADC = \frac{(V_{pos} - V_{neg}) * GAIN * 512}{V_{ref}} \quad (3.3)$$

$V_{pos}$  = fs5's output voltage

<sup>5</sup>Acoustic Impedance: "Measure of how easily the air in the flute vibrates at any given frequency" [Maclagan, 2009]

<sup>6</sup><http://cdn.sparkfun.com/datasheets/Dev/Arduino/Boards/ATMega32U4.pdf>

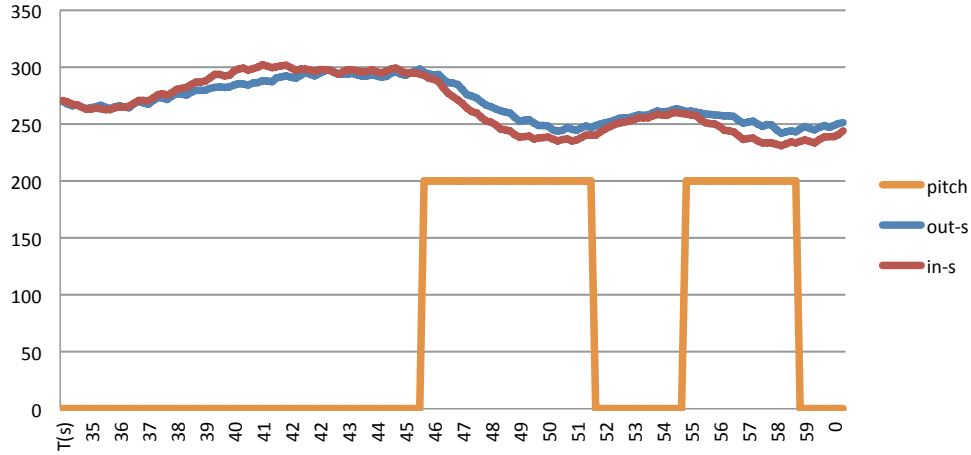

**Figure 3.9:** Flow sensor data. Y axis shows ADC codes, X axis shows the actual second

ADC codes were  
obtained from the  
two airflow sensors

$$\begin{aligned} V_{neg} &= 0.58v \\ V_{ref} &= 1.56v \\ GAIN &= 10x \end{aligned}$$

In summary, we obtained ADC codes from the flow sensor inside and outside. Figure 3.9 shows the data acquired by the two airflow sensors using an arbitrary smoothing parameter of 0.2. We added a curve that represents the presence of pitch detected (they are not frequency values). These curves suggest a pattern showing places where the sensor inside cooled faster than the sensor outside. This pattern helped us to identify the amount of air jet needed in both locations when sound was present.

Additionally, we calculated another feature *delta* based on sensor values:  $delta = out_{sensor} - in_{sensor}$ . This feature was useful to improve the classification of a player performance's (see 3.3.3 section).

### 3.2.3 Sensing lip hole shape

The lip hole shape regulates the amount of air going across the lips. If it is too wide, the air jet will hit the walls of the embouchure hole and produce a windy sound [Putnik, 1970]. Reinette indicated that a wide aperture of the lip hole allows an unfocused air jet [Wilcocks, 2006]. Therefore, the amount of windy noise in a tone is highly related to the lip hole gesture. We decided to acquire indirectly the lip hole gesture through signal processing of the resulting sound. The use of cameras could be an alternative, however, noise analysis of tone can be used to estimate the shape of the lip hole.

Flute tone has been considered pure due to the short harmonic development [Fletcher, 1974]. Using Fourier analysis, we were able to visualize the harmonic development as well as the presence of noise of a stable flute tone (see Figure 3.10). For our prototype, we wanted to know the proportion of noise regarding the volume of the actual tone. If it was high, this meant that the sound was noisy and the player should check his lip hole shape. Therefore, we defined a threshold based on the experienced flutists group data. The features needed for this analysis were: amplitude of the original signal, frequency of the tone (pitch) and amplitude of the filtered signal (residual signal without harmonics). With those values we calculated the amount of noise in the signal applying a simple linear relation:

$$\% = \frac{a}{b} * 100 \quad (3.4)$$

$a$  = amplitud of residual signal in dB

$b$  = amplitud of original signal in dB

We used [PureData](#)<sup>7</sup> (Pd) to extract the sound features in real time and to send them to the main application. Furthermore, we used two patches<sup>8</sup> for the audio processing: *pitchEnv~* and *sigmund~*. The first patch is used to attenuate the harmonics to get the residual signal (approximately

<sup>7</sup>PureData is an open source visual programming language to process or create sound, video, graphics, sensors, etc. <https://puredata.info/>

<sup>8</sup>Patch is a program developed in Pd

A non-clean tone is highly related to the lip hole gesture

A flute tone has a short harmonic development

Noise-tone volume proportion can define a non-clean tone

Noise-tone proportion as a linear relation

A patch in Pd was used to obtain the sound features in real time

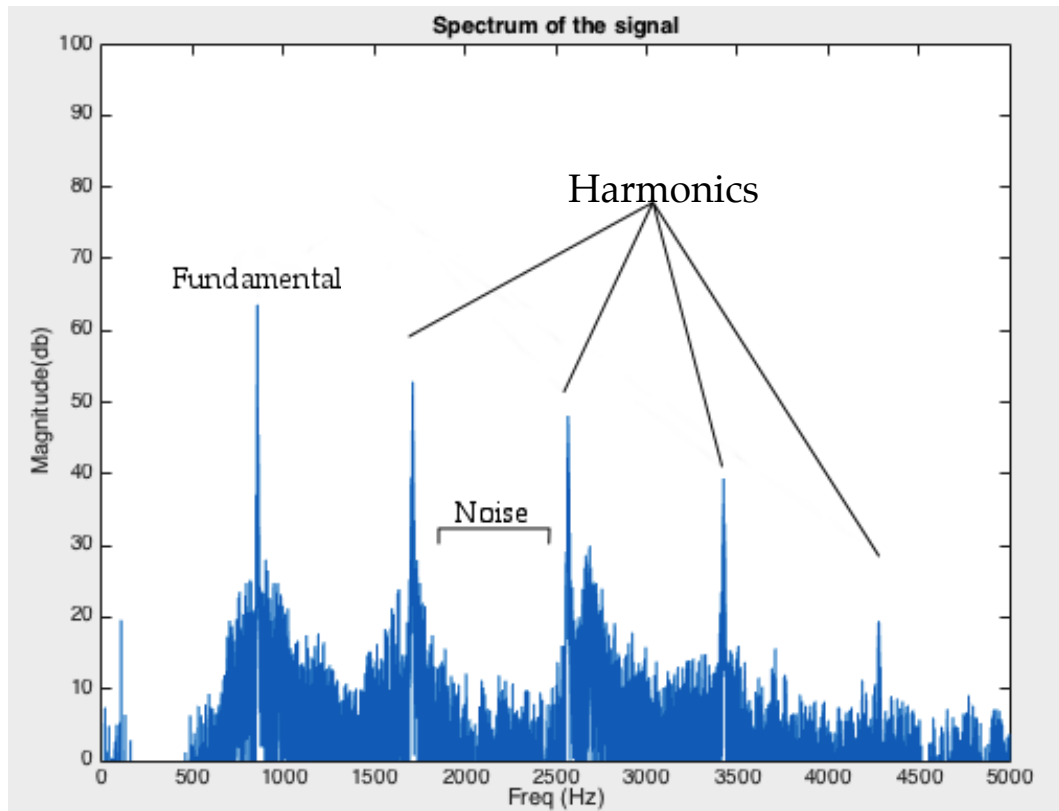

**Figure 3.10:** Frequency spectrum of a flute tone obtained applying Fourier analysis. A Hanning window function was applied with a size of the data length and a sample rate of 44100

*sigmund~* track the  
pitch frequency

*pitchEnv~*  
manipulate the  
amplitude of the first  
40 harmonics

the noisy part) and the second one was used to track the pitch frequency of the signal. The complete patch is shown in Appendix B. Additionally, we used [OSC](#)<sup>9</sup> protocol to send the results of the audio processing from this patch through the network.

William Brent implemented *PitchEnv~* to manipulate the amplitude of the harmonics. It receives the input signal, the frequency of the fundamental, a table of 40 values (as weight values for each harmonic) and the size of the window. It needs the fundamental frequency to find the first 40 harmonics. Then, it multiplies the harmonics with the table of the same size to manipulate the amplitude of the harmonics. At the end, it synthesizes the signal with the

<sup>9</sup>Open Sound Control

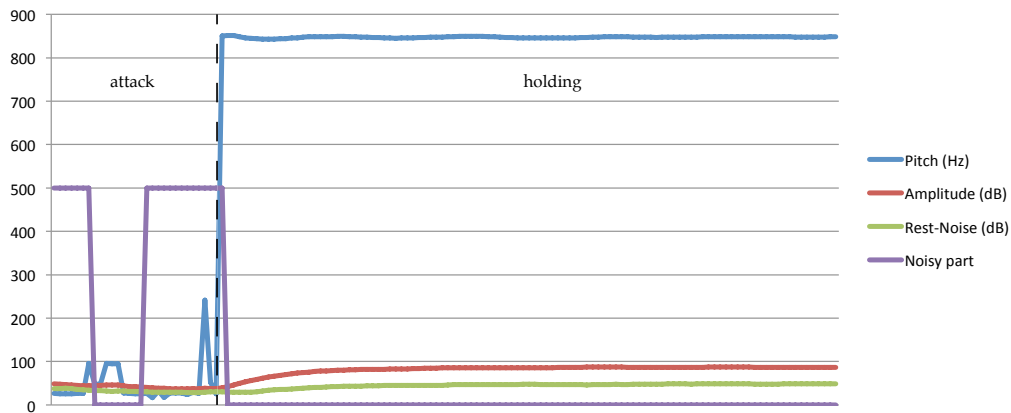

**Figure 3.11:** Data from expert B (see Evaluation Chapter) using the patch of Pure-Data

modified amplitudes.

For our purposes, we used *pitchEnv~* to filter most of the audible harmonic frequencies including the fundamental (setting all the 40 values to zero). Figure 3.12 shows the Fourier analysis of the filtered signal in red and the original signal in blue.

*pitchEnv~* was used to mute the first 40 harmonics

The output of this patch is shown in Figure 3.11 (pitch in Hertz, amplitude of the signal (dB) and amplitude of the signal without 40 first harmonics (dB)). The purple curve represents the part of the signal where the noise proportion (Eq. 3.4) was more than 75%. It is normal to expect noisy parts specially when the playing starts (*attack* state) as the air jet is not stable at the beginning. The chart shows part of the data recorded from expert B during the user study for experienced players.

Air jet is not stable at the beginning of the playing, which produces noise

There are other noises that can affect the signal, e.g. noise in the environment, noise produced by electronic components, etc. It is impossible to eliminate all these noises; however, we attempted to limit external noises during the recording. (see details in the Evaluation Chapter).

Noise in the environment affects the system

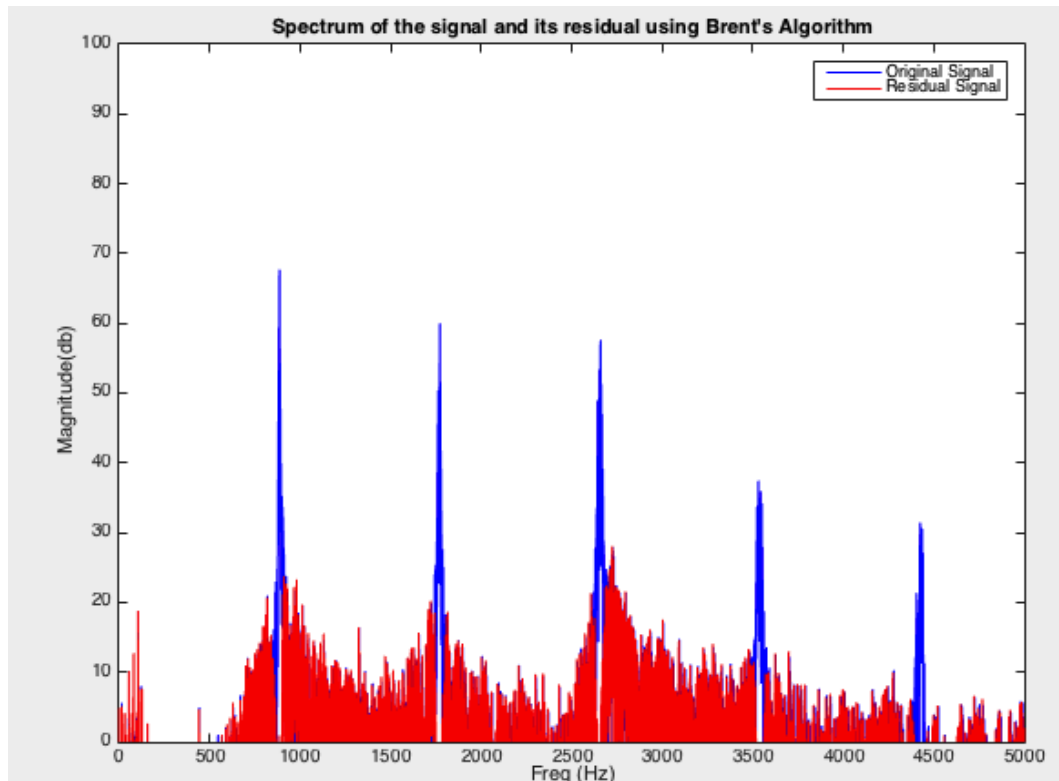

**Figure 3.12:** Blue signal shows the original signal frequency spectrum. Red signal shows the filtered signal using the algorithm. Spectrum of a flute tone obtained applying Fourier analysis with a Hanning window function of the size of the data and a sample rate of 44100

### 3.2.4 Other considerations

Battery consumption exceeded our expectations

The capability to send data via Bluetooth was implemented in the hardware., but battery consumption was more than expected (about 170 mAh). Increasing the battery capacity implied adding weight to the system. Thus, we decided to drop the connectivity via Bluetooth and connect the system via USB instead.



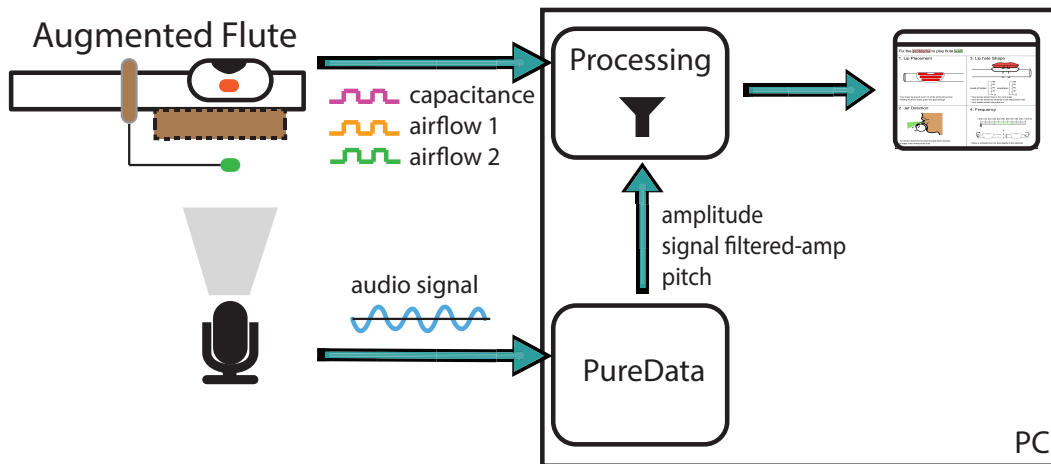

**Figure 3.13:** Diagram of the whole system of the augmented flute (Hardware and Software)

### 3.3 Software prototyping

#### 3.3.1 Main program

The main program was created to display the data obtained with the augmented flute to give learning support to beginners. The program was written in [Processing](https://processing.org)<sup>10</sup>. It receives data from the augmented flute through a serial port and from the patch in PureData through OSC. Figure 3.13 shows the communication between the augmented flute and the application.

Main program displays data from the augmented flute to support beginners

The main program interface had four sections per parameter:

Main program has four sections

- The lip plate section displays the data from capacitive sensors.
- The jet direction section displays the data from the airflow sensors.
- The jet bandwidth (lip hole shape) and tone (fre-

<sup>10</sup><https://processing.org>

quency) sections display the data from the audio signal processing.

We decided to use simple drawings per section and dynamic coloring to show the action performed. We followed an incremental design that had 3 iterations. The three visual designs will be described in this chapter. Each iteration was evaluated and the results can be found in Chapter 4.

### 3.3.2 First design

Lip plate section: Lip plate image with rectangles which represent capacitive sensors

Each rectangle had three-color states: white, green and red

States are decided by ranges

*Lip Plate section* .- This section showed a lip plate image with the foil sensors represented by rectangles (see Figure 3.14). The program gathers data from the capacitive sensors (3 foils) and colors the rectangles according to the defined boundaries. In this version, the rectangles had three-color states: *white* - no pressed, *green* - good lip placement and *red* - wrong lip placement. A *white* state represented no lip detection when the sensed values were around 27, 16 and 25 for *Y*, *B* and *R*. A *green* state represented good lip placement. It was shown when the sensed values were between boundary values. A *red* state represented wrong lip placement. It was shown when the sensed data was higher than the upper boundary value. The boundaries for the *green* state, were based on data from an inexperienced player. They are shown in Table 3.3. Additionally, when all three rectangles were green, a check icon was shown; otherwise, a no-check icon was shown instead. This means that this task required all three sensors to reach the *green* state in order to complete this section.

Thresholds - Lip Sensor			
Boundaries	Y	B	R
Upper	8600	3200	2000
Lower	6000	1000	700

**Table 3.3:** Boundaries of *Green* state (proper lip placement) - First design. *Y*, *B* and *R* are the capacitive foil sensors

Jet Bandwidth section had three states: close lip hole, good lip hole and wrong lip hole

*Jet Bandwidth section* .- This section showed an image of the

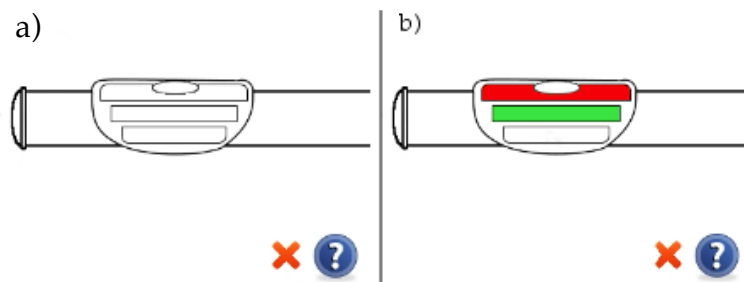

**Figure 3.14:** Lip plate image with three rectangles that simulates the sensors of the covering area

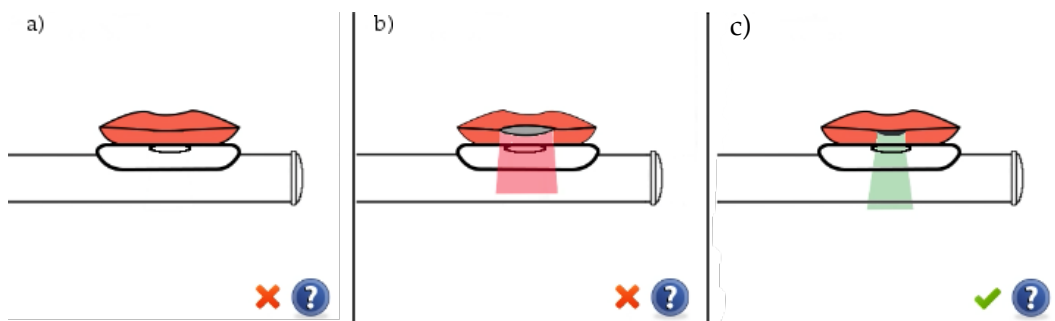

**Figure 3.15:** Lip hole shape in three states: a) close lip hole - no sound detected, b) good lip hole - amount of noise tolerable, c) wrong lip hole - amount of noise not tolerable

lip position on the lip plate. It had three states (see fig. 3.15): close lip hole, good lip hole (green air jet) and wrong lip hole (red air jet). The jet bandwidth state was decided through noise analysis of tone. When noise-tone ratio was less than 75% (arbitrarily defined), *good lip hole* was shown, otherwise *wrong lip hole* was shown. *Close lip hole* was shown when the tone amplitude was less than 46dB. When the state was in *good lip hole*, a check icon was shown, otherwise a no-check icon was displayed.

Noise-tone ratio acceptable less than 75%

*Jet Direction section* - This section showed a player from a perspective of 90 degrees. This section had two states (see fig. 3.16): wrong air jet (red air jet) and good air jet direction (green air jet). *Good air jet direction* was shown when the data range was between 260 – 190 for both airflow sensors, otherwise *wrong air jet* was shown. A check icon appeared when the jet had a good direction; otherwise a no-check

Jet Direction section had two states: wrong air jet and good air jet direction

Air jet acceptable for both sensors was between 260-190

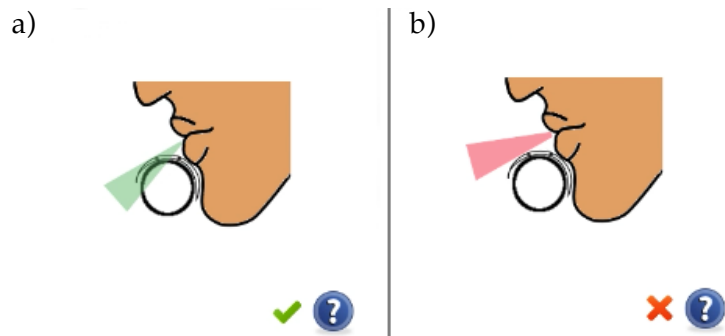

**Figure 3.16:** Jet direction with two states: a) good air jet direction, b) wrong air jet direction. Picture adapted from Putnik [1970]

icon was displayed.

Tone section was  
informative

*Tone section* .- This section showed the frequency in Hertz in which the tone was performed. This section was only informative, i.e. it gave neither state, nor additional instruction, unlike the previous stages.

Each section was  
shown sequentially

This design showed each section one at a time. At the end, all sections were shown at once (see fig. 3.17). The blue icon with a question mark was added to include help text for the user, however, we noticed that the user only interacted with the flute; therefore, this icon was removed in the next iterations. The boundaries defined to evaluate the data sensed were based on the data produced by an inexperienced flutist. During the tests, the results from experienced flutists showed that the thresholds were inadequate (see Chapter 4); therefore they were reformulated as follows.

Acceptable ranges  
were found  
inadequate

### 3.3.3 Defining thresholds

Data from  
experienced flutists  
were collected to  
update the  
thresholds

Four experienced flutists named A, B, C and D evaluated the first design. The players have 12, 20, 13 and 20 years playing flute respectively. In this evaluation, we collected data from them to validate and update the thresholds for the parameters. The details of this case study are shown in

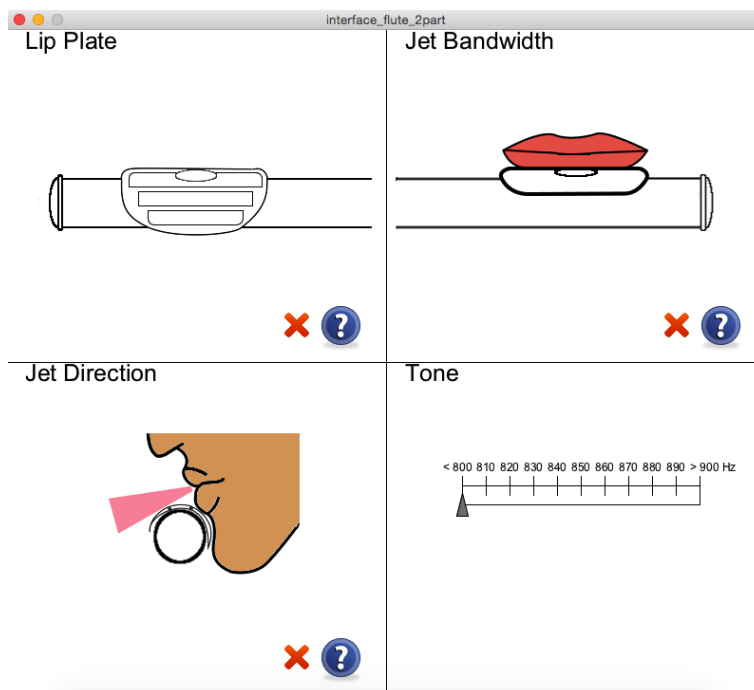

**Figure 3.17:** All sections enabled (Lip Plate, Jet Bandwidth, Jet Direction and Tone)

#### Chapter 4.

Thresholds - Lip Sensor			
Bounds	Y	B	R
Upper	7000	2600	240
Lower	5000	1700	112

**Table 3.4:** The upper and lower bounds are the limits of playing well. Y, B and R are the capacitive foil sensors

We used the data from experienced flutists to feed a data mining software called [WEKA](http://www.cs.waikato.ac.nz/ml/weka/)<sup>11</sup>. This software allowed us to apply machine-learning algorithms and classify the data into good or bad playing. We used C4.5 algorithm (Quinlan [1993]) to build a decision tree for the air jet and lip hole shape parameters. Figure 3.19 and 3.18 shows the results as flow charts respectively. The thresholds for the lip covering

<sup>11</sup>[www.cs.waikato.ac.nz/ml/weka/](http://www.cs.waikato.ac.nz/ml/weka/)

Decision trees were obtained from the data collected

Thresholds for capacitive sensors were not based on decision rules

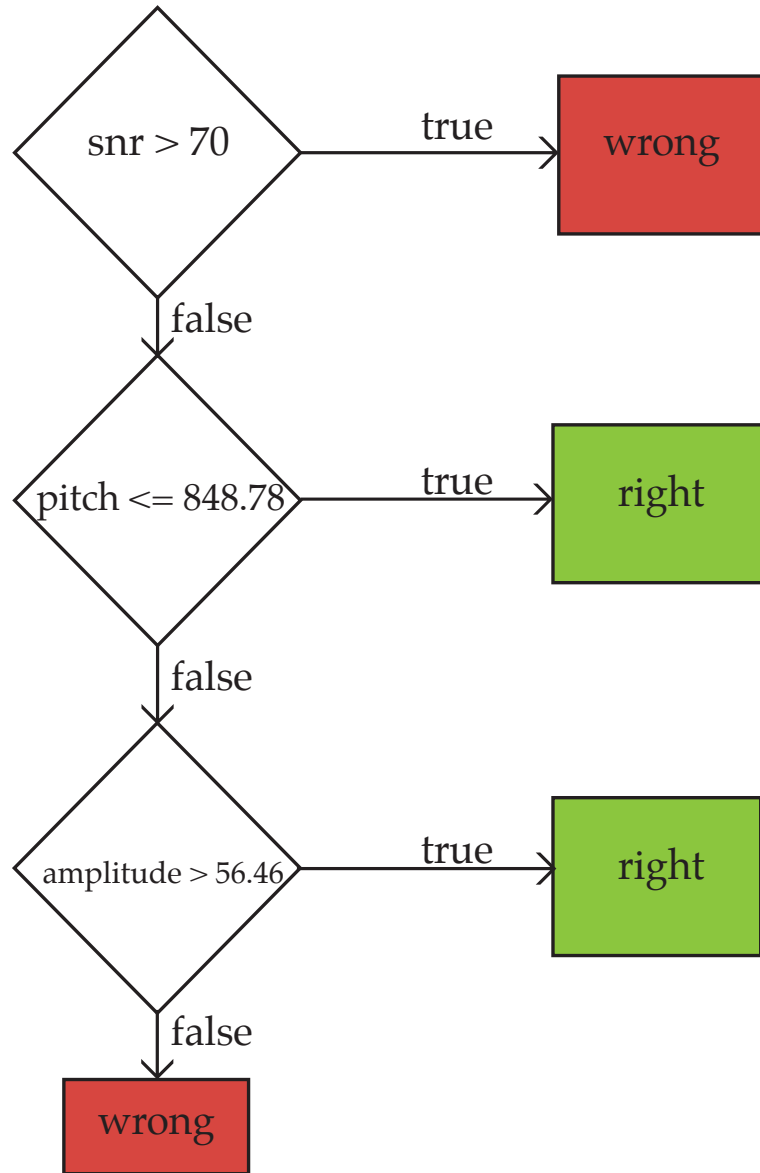

**Figure 3.18:** Decision trees expressed into a flow chart. The output can be “wrong” = wide lip hole or “right” = right lip hole shape

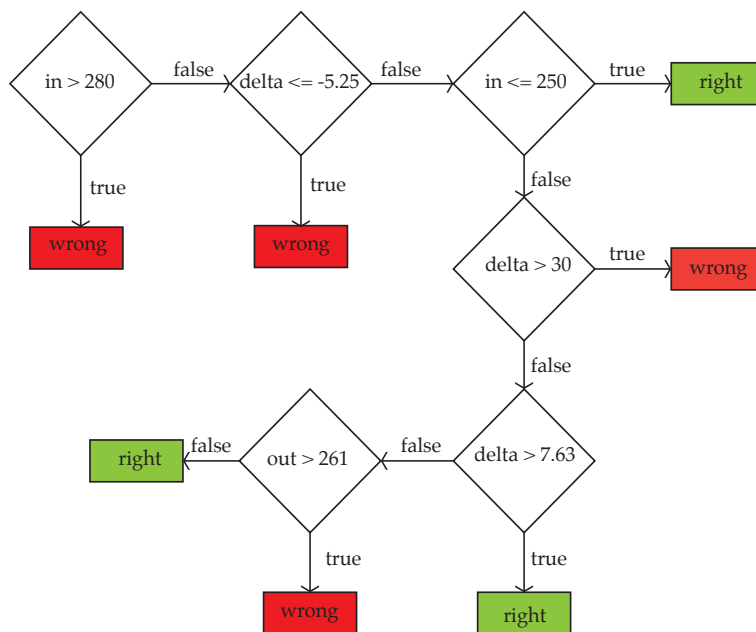

**Figure 3.19:** Decision trees expressed into a flow chart to judge air jet direction. The output can be “wrong” = incorrect air jet or “right” = right air jet direction

sensors were not selected using the WEKA tool because the ranges obtained showed ambiguity (11 rules). Therefore, we chose the ranges based on the maximums and minimums from the observed data (Table 3.4).

### 3.3.4 Second design

For the second design, we introduced the rules from C4.5 algorithm based on the data from the experienced flutists. The rules were implemented in the code except for the Lip Plate section, where we applied maximums and minimums as thresholds (Table 3.4).

Second design included the decisions rules

*Lip Plate section* .- This section has the same illustrations and functionality as the previous version, but the “white, no-pressed” state was removed. An experienced player

The “white, no-pressed” state was removed

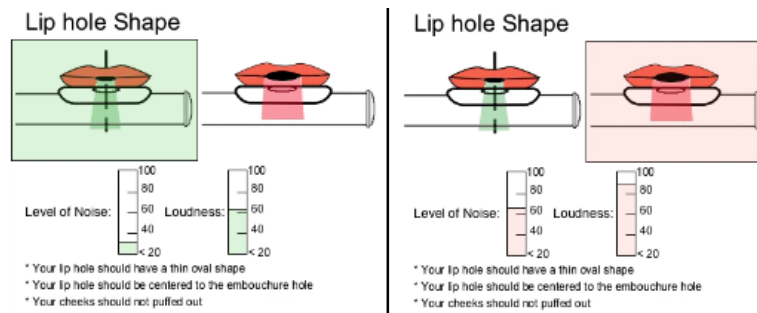

**Figure 3.20:** Lip Hole Shape section that indicates wrong/good position. The left side shows a good position, the right side shows a wrong position

found this parameter confusing, so it was narrowed down to only two states: *red* - wrong covering and *green* - good covering. The *green* state required that the data received by the corresponding foil be within the boundaries for proper playing. (see Table 3.4). If it was higher than the upper boundary, the *red* state was shown.

Images showed the two states: good lip hole and wrong lip hole

Indicators of tone quality were added

Wrong air jet corresponds to unfocused airflow image, good air jet corresponds to focused airflow image

*Jet Bandwidth section* .- This section was renamed to “Lip Hole Shape”. The two states were shown as images, which were selected by a light-color rectangle. The rectangle selects one state according to decision rules (see Figure 3.20). This section included two additional bars: Level of Noise and Loudness. They were also colored according to the rules.

*Jet Direction section* .- This section had two states, one of which will be selected by a light-color rectangle. Figure 3.21 shows the two states. The image on the left side shows a focused airflow, while the other side shows an unfocused airflow. The selected state was chosen using the decision rules of the flow chart, Figure 3.19.

*Tone* .- This section was renamed as *Frequency*. It had the same behavior as the previous version, but the area where the right frequency should be was specified (see Figure



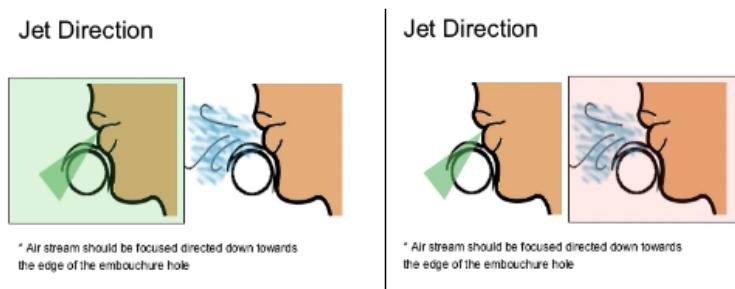

**Figure 3.21:** Two images show two states of the Jet Direction section. The left side showed a good air jet direction, the right side showed a wrong air jet direction. Picture adapted from Putnik [1970]

## Frequency

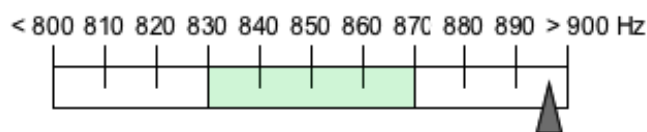

Musical tones can be translated to Frequencies in Hertz (Hz)

**Figure 3.22:** Frequency bar showed the frequency played

3.22).

### 3.3.5 Third design

The third design incorporated continuous and directional feedback in each section (Lip Placement, Jet Direction, Lip Hole Shape and Frequency).

Third design added continuous and directional feedback

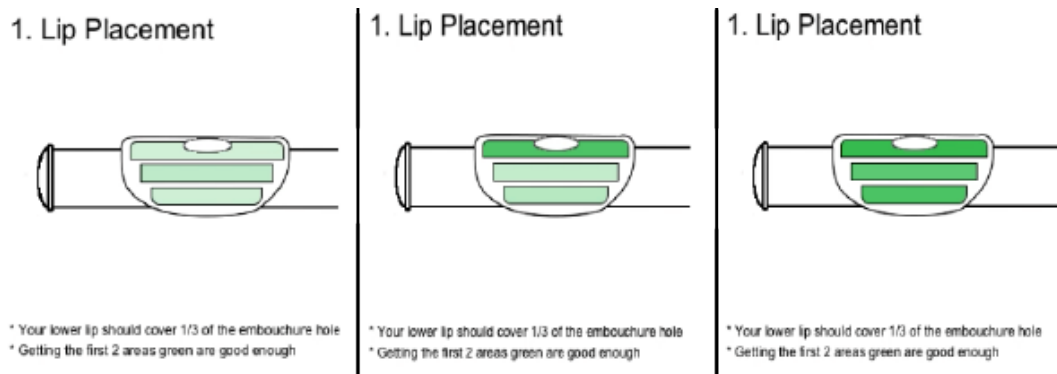

**Figure 3.23:** Sequential images showing from partial covering to a good placement of the lips on the lip plate

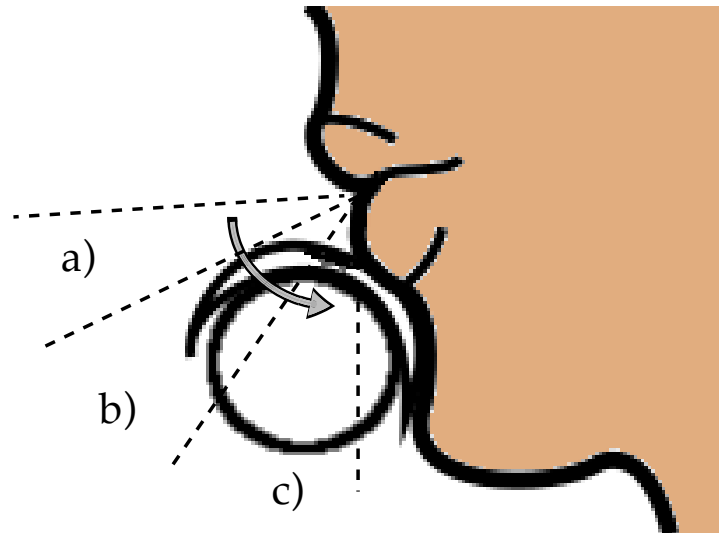

**Figure 3.24:** Triangle rotation from area a) to c) to simulate air jet direction. Picture adapted from Putnik [1970]

Intermediate states were added through gradient colors

*Lip Placement section* .- In this section we incorporated intermediate states between: white - no pressed, green - good covering, red - wrong covering. The intermediate states consisted of gradient colors. For example, if the player's chin covers the required area partially, the color showed was light green (see Figure 3.23).

Triangle rotates in three areas to indicate the air jet direction

*Jet Direction* .- For the air jet direction, we added two more features to the animation: direction and power. For the di-

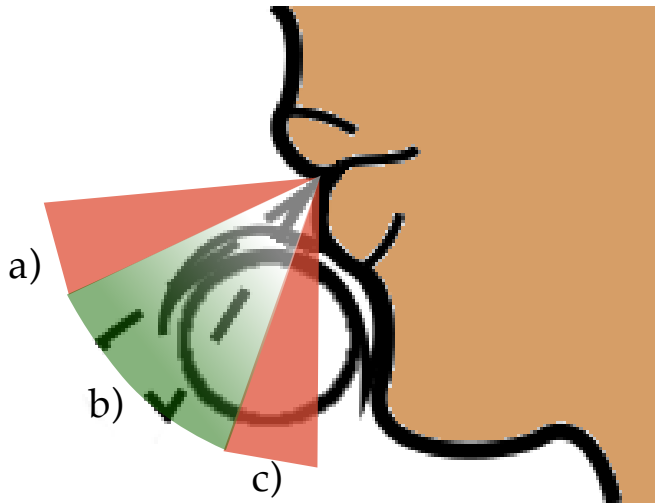

**Figure 3.25:** Three areas of air jet direction colored: a) and c) are the wrong areas and b) is the right area. Picture adapted from Putnik [1970]

rection, we used a rotating triangle, which simulates the air jet direction, about 5 to 90 degrees, counterclockwise. The areas are shown in the Figure 3.24. Area a) and c) indicated wrong angle of the air jet, while b) indicated a good angle. The limits were adapted based on the rules obtained from the machine learning tool (Second design). The algorithm 1 describes this functionality.

Decision rule was adapted to support air jet rotation visualization

---

**Algorithm 1:** Triangle rotation - Air jet angle

---

```

if outSensor between (230,240) then
  | // air jet is mostly outside
  | rotate to area a
if outSensor between (240,262) then
  | // air jet is in the range
  | rotate to area b
else
  | // air jet is mostly inside
  | rotate to area c

```

---

Power of the air jet was indicated by the height of the

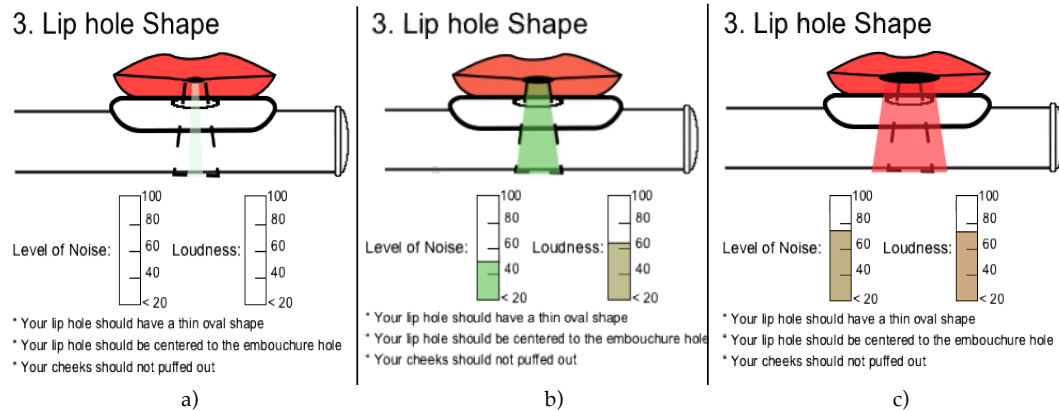

**Figure 3.26:** Lip hole shape animation: a) small lip hole shape, b) proper lip hole shape, c) wrong lip hole shape

Power of the air jet  
was displayed as the  
triangle height

The triangle were  
colored according to  
the areas

triangle. Additionally, the triangle area was colored according to the three areas (a, b or c). The correct area *b* had a gradient color between white and green to denote amount of air jet power needed, the other two areas (*a* and *c*) had a solid red color. The areas are shown in Figure 3.25. The implementation of this behavior is shown in pseudo-code, Algorithm 2. The *flowSensor* variable in Algorithm 2 represented the data from the external sensor. We decided to use this arbitrarily as a reference for the mappings (color and height of the triangle).

---

**Algorithm 2:** Fill color - air jet area

---

```

triangleWidth ← mapping (flowSensor)
if isAirJetMostlyOutside () then
    // area a
    outputColor ← red
else
    if isAirJetMostlyInside () then
        // area c
        outputColor ← red
    else
        // area b
        gradientGreen ←
        mapping (flowSensor, whiteGreenColor)
        outputColor ← gradientGreen

```

---

*Lip Hole Shape* .- In this section, we modified the animation

based on the decision rules (Figure 3.18) and observed data. The width of the lip hole was related to the noise detected. For this, the amount of noise in percentage from the formula 3.4 was used to animate the lip hole width and the color. Basically, we related tone-noise proportion values from wide to proper lip hole shape. The amplitude of the tone was used to animate the air jet before producing any sound. This is detailed in Algorithm 3.

Noise-tone proportion was used to animate lip hole shape

Audio amplitude was used to animate the air jet

Three snapshots of the animation of this section are shown in Figure 3.26. On the left side, it shows a small lip hole, which produces a very thin air jet. In the center, it shows a thin lip hole with a good lip hole size and on the right, it shows a wide lip hole. In this section, we maintained the use of Noise Level and Loudness bars as in the previous version.

---

**Algorithm 3:** Algorithm to animate the lip hole shape based on SNR values

---

```
temp ← 0
snr ← residualAmplitude/signalAmplitude * 100
if signalAmp > 56 then // sound or high level of
noise detected
  temp ← snr
  if snr ≥ 75 then // sound very noisy
    flowSize ← mapping snr with wider lip hole
    outputColor ← red
    drawBigLipHole (flowSize)
  else // good sound
    flowSize ← mapping snr with thinner lip hole
    outputColor ← green
    drawThinnerLipHole (flowSize)
else // not enough air
  temp ← signalAmplitude
  flowSize ← mapping temp with a smaller lip hole
  gradientGreen ← mapping temp with a white-green
  color
  outputColor ← gradientGreen
  drawSmallerLipHole (flowSize)
```

---

*Frequency* .- In this section, we added instructive feedback. Two additional images indicated the direction that the flute

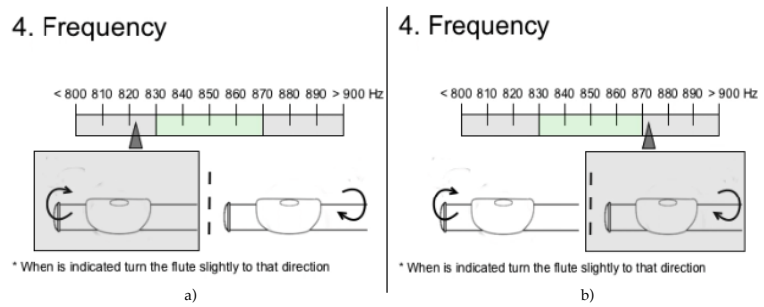

**Figure 3.27:** Frequency section with the highlighted instruction: a) turning out, b) turning in

Instructive feedback  
provided to tune the  
tone

should be turned in or out, in order to obtain the right frequency. When the frequency was between 800-830 Hz, the image on the left was highlighted and vice versa, if the frequency was more than 870 Hz, the image on the right was highlighted. This is illustrated in Figure 3.27. When the frequency was in the right range, none of the images were highlighted.

## Chapter 4

# Evaluation

In the previous chapter, we explained the augmented flute hardware design and three versions of the interface. The augmented flute interface was tested first with experienced players and twice with beginners. For each iteration we conducted a user study to evaluate the usability of the augmented flute interface. Each iteration lead to improvements of the design based on the comments obtained. We gathered qualitative data for analysis and measurements in the form of video, audio recording and surveys. And finally, we compared and discussed the results obtained from testing these two versions of the interface with beginners.

Three user studies were done: one with experienced flutists and two with beginners

### 4.1 User study with experienced players

We conducted a user study with experienced players to collect embouchure data and to evaluate the interaction with the augmented flute interface (First design). With the data collected, we could apply a machine-learning algorithm (C4.5) to obtain the decision tree for the indicators of good blowing technique added in the Second design.

Aim of the user study was to collect qualitative data and evaluate first design

### 4.1.1 Task

User study had two parts	The task had two parts. The first part involved recording embouchure data from experienced players. In the second part, experienced players evaluated the interface interaction. In both tasks, the participant was one meter away from the microphone.
Data from flutists were collected in the first part	The first part consisted to play a tone twice without any articulation and vibrato. The tone had to have duration of 4 seconds each time with a pause of 4 seconds in between. For this, we developed a graphical counter program to guide the participant. It was indicated that the counter was meant as a guide, and they were not required to follow the program strictly. This task was repeated twice and only if errors were found during the acquisition of data.
Second part involved interaction evaluation with the application	For the second part, a think aloud method was used to evaluate the application of the first design. The application had 4 sections and each section was shown separately. At the end, all sections were enabled and shown. For each section the participant was required to play and explore the section. Then, the participants were asked to say what they thought about the section and a questionnaire was handed out for them to fill out after each task.
Think aloud method and questionnaires were employed	

### 4.1.2 Apparatus

For the user study, we used a mac book pro 13" to run the counter program and the augmented flute application. An external monitor of 2560 x 1600 pixels was used to show the interface. The augmented flute was connected through a serial port. We used a USB extension to give room for movement to the participant. For the audio recording we used an external interface [M-Audio FireWire Solo](http://www.musiciansfriend.com/pro-audio/m-audio-firewire-solo-mobile-audio-interface)<sup>1</sup>, and a small diaphragm condenser microphone *Fame* held with a microphone stand. The microphone was at 1 meter of distance from the participant. The recordings were performed

<sup>1</sup><http://www.musiciansfriend.com/pro-audio/m-audio-firewire-solo-mobile-audio-interface>



in a regular room very quite (around 46dB) and after office hours to decrease environmental noise. In addition, we used a GoPro camera for video recording, located at an angle of 30 degrees from the participant.

### 4.1.3 Participants

In this study we gathered 4 experienced players: 3 advanced and 1 intermediate. Three of them were females and one male. We asked the participants to state their age into two ranges: 12-25 or 26-39 years old. Two of them selected the range of 12-25 years old and the other two selected 26-39 years old. They had 12, 20, 13 and 20 years of experience playing flute respectively, and they all played in an orchestra.

Four experienced flutists participated in this study

### 4.1.4 Case study design

The study was a between-subject study. We required that the participants were more than 12 years old and also active flute players. In order to decrease the unfamiliarity with the instrument, we allowed them to try the flute for 2 minutes before starting the tasks. This study performed two tasks. The first task was for data acquisition and the second task for evaluation of the interaction with the interface. During the second part of the task we made open questions about the usability of the augmented flute with the interface. The parameters measured were: lip-plate covering area, amount of air jet inside and outside the flute, frequency and noise produced.

The study follows a between-subject design

Data recording involved measuring embouchure parameters

### 4.1.5 Questionnaire

We performed two questionnaires. The first questionnaire collected the player's background data: gender, age, years of experience and competency level. They were asked about their experience after playing the augmented flute, and asked to mention any problems or discomfort. In the

First questionnaire collected players' background data and experience with the augmented flute

Second  
questionnaire  
evaluated usability of  
the first design

second questionnaire, we evaluated the usability of the interface. There were four questions to be rated in a 5-point Likert scale:

- I believe that this application will be useful for beginners.
- I could easily detect which parameter to change to get a better result.
- I felt supported by the augmented flute.
- I could easily find out how to get a better result.

Additionally, we asked if they would add any other feature to the application. At the end, we inquired about any feeling of stress during the experiment or further comments or suggestions about the application.

#### 4.1.6 Results

A: sensors did not  
disturb the  
performance  
C: it took time to find  
a good placement  
B: Sound might be  
compromised, but  
was not sure  
D: Flute teacher  
cannot be replaced

We referred to the participants as expert A, B, C and D. From the comments, expert A reported that although she could feel the sensors on the lip plate, it did not disturb her playing. Additionally, she said that playing a different flute normally takes time to get used to. Expert C reported feeling the sensor foils and she needed some time to find the correct placement to lay her embouchure. Expert B reported that he had no problems to play the augmented flute. He commented that the tone quality seemed compromised by the sensors but he could not be completely certain. Expert D reported that she had no problems playing the flute and took a lot of interest on the instrument. However, Expert D stated that the augmented flute cannot be used as a replacement of a flute teacher as there are other parameters like breathing and body posture that are not corrected by the augmented flute.

Comments and suggestions about the interface application (First design):

- Expert B would prefer continuous classification rather than binary classification in *Lip Plate* section.
- Expert B would prefer to see SNR in *Jet Bandwidth* section.
- Expert D stated that showing the loudness of the sound would be helpful.
- The target zones (to reach proper states) should be adjusted (expert B, expert C).
- Expert C reported that to obtain the *green* state on the *Lip Plate* section, she had to press her chin against the lip plate.
- Expert C reported that the illustration of the *Jet Direction* section looked like blowing while lowering the head, which is incorrect.

Suggestions regarding adjustments of the thresholds and improvements of the feedback

These comments were taken into consideration for the next iterations.

The results for the four questions in 5-point Likert scale are shown in Figure 4.1. The y-axis shows the percentage of participants ( $N = 4$ ) that rated the corresponding option. Additionally, the results were coded to *strongly agree* = 1, *agree* = 2, *neutral* = 3, *disagree* = 4 and *strongly disagree* = 5.

The results of question *a* showed 2 experts ( $N=4$ , 50%) said that the augmented flute can be useful for beginners while the remaining participants couldn't decide (*Median* = 2.5, *SD* = 0.96). In contrast, participants showed (in question *b*) agreement that it was easy to determine which parameter to change (*Median* = 2, *SD* = 0). In question *c*, participants did not feel supported by the augmented flute (*Median* = 3.5, *SD* = 1.71). In question *d* (*Median* = 2, *SD* = 1.26), 3 experts ( $N=4$ , 75%) stated agreement that they could easily find out how to get a better result but one expert ( $N=4$ , 25%) disagreed.

50% stated that the application can be useful for beginners

Agreement (100%) on question *b*  
50% did not feel supported by the application

We suspect that the low rating in question *a* and question *c*, could be related to threshold definitions. We attempt addressing these issues in the next iteration.

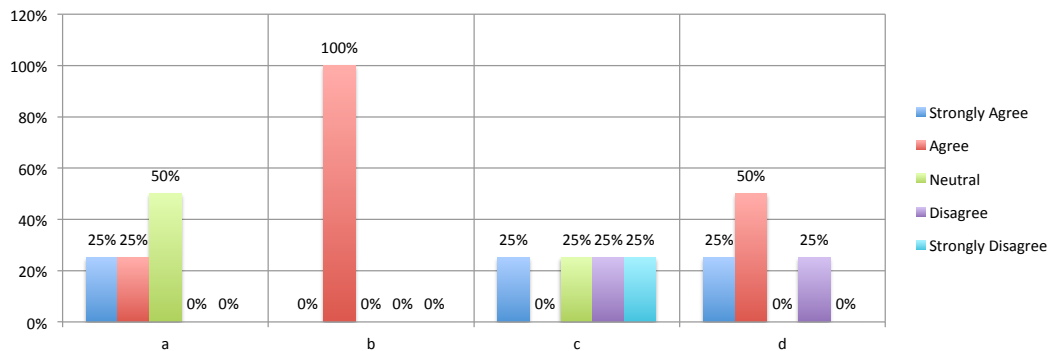

**Figure 4.1:** Results from 4 experts that answered the usability questionnaire: a) I believe that this application will be useful for beginners b) I could easily detect which parameter to change to get a better result, c) I felt supported by the augmented flute, d) I could easily find out how to get a better result

## 4.2 First iteration with beginners

Improvements were added to second design

For this iteration we changed the pictures of *Lip Hole Shape* and *Jet Direction* sections in order to make it clearer what the participant was doing incorrectly, and text was added to remind the user to follow the instructions. Bars regarding tone quality were added in the *Lip Hole Shape* section, and a green target area in the *Frequency* section was indicated in the bar.

### 4.2.1 Task

Two parts: 1) intro to the flute and 2) usability evaluation of the application

The experiment had two parts. In the first part, we provided the participants some basic knowledge of the embouchure and terminology of the flute. At the end of the introduction the evaluator showed how to play the flute. Afterwards, a condition was randomly applied to the participants. The condition consisted to let the participant play a normal flute (only the head joint without sensors). With this condition, we tried to identify which participants could produce sound easily with the flute. The condition was not applied to all participants as it could bias the performance. In the second part, the participants were asked to use the application along with the augmented flute. While

Open questions were made in second part

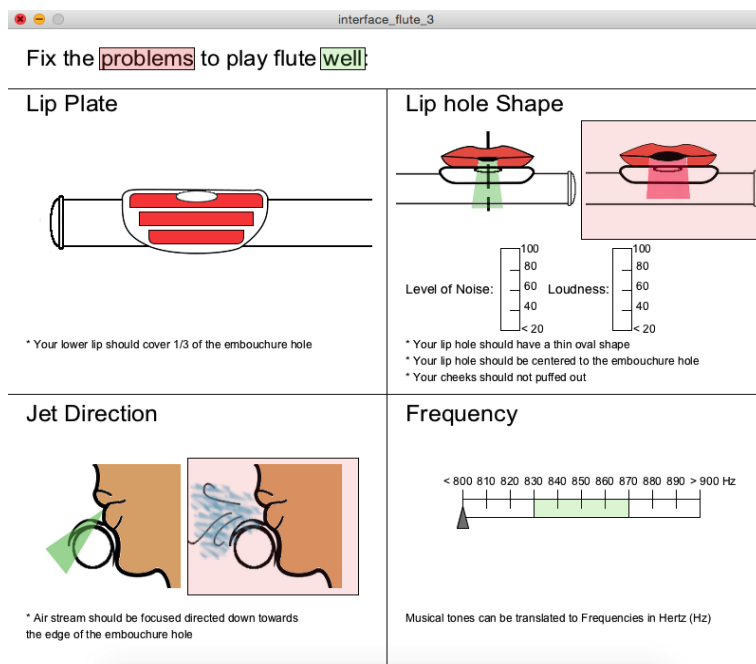

**Figure 4.2:** The augmented flute interface tested with beginners (Second design)

they were exploring, open questions were made in order to know their understanding about the application to find out whether they understood the pictures and if they knew or could explain what they were trying to do.

The application interface (Second design) is shown in Figure 4.2. The user was asked to fix the problems in red while playing the flute. In this version we showed all the sections at once, and the user was told to focus on one section at a time in order from one through four.

All sections were shown at once

### 4.2.2 Apparatus

The same equipment was used and it employed the Second design of the augmented flute application.

### 4.2.3 Participants

Five beginners participated  
Three reported to have played wind instruments

Study follows between-subject design

We gathered five beginners for this study: 4 males and 1 female. Three of them were between 12-25 years old and the rest were between 26-39 year old. Three of them reported to have played: flute, pan flute and recorder. And all of them have played other non-wind instruments. The study was a between-subject study since we were analyzing the interaction of each participant with the augmented flute. We exposed two participants to try a normal flute (only the head joint); both were able to produce sound.

### 4.2.4 Case study design

Participants without split embouchure

Think aloud method and questionnaires were performed

The study required participants without any split embouchure (see fig. 2.4) in order to do the experiment and being at least 12 years old. Moreover, the study required beginners with or without knowledge in playing flute. The independent variable was the condition of whether they had been or not exposed to a conventional flute. The parameters to measure with the augmented flute were the following: the lip plate covering area, the amount of air jet outside the flute, the amount of air jet inside the flute, frequency played and the amount of noise present in the signal. During the study we made open questions and invited the participant to ask questions and describe what they were trying to do (think aloud method). The evaluator was there to assist and answer any questions from the subjects. At the end, they were asked to fill out a questionnaire. The estimated time to finish the study was about 30 minutes.

### 4.2.5 Questionnaire

The questionnaire remained the same for all the iterations and was divided in three sections. The first part inquired the player's musical background: previous experience learning the flute, learning methods, and other instruments. The second part inquired about their experience with the augmented flute, any discomfort or feelings

of stress during the experiment. Additionally we added a text box at the end of the questionnaire, where they could describe their feelings and comments about the augmented flute. On the third part, we asked about the usability of the augmented flute interface using a 5-point Likert scale. We asked three points regarding the usability of the interface:

- I could easily detect which parameter to change to get a better result
- I felt supported by the augmented flute
- I could easily find out how to get a better result

At the end, another box was provided in order to add any more comments or suggestions.

#### 4.2.6 Results

The results for this iteration, regarding the interaction with the application interface (Second design), showed agreement with the expert's comment about adding a continuous classification of the performance. We omitted this change in this iteration because we wanted to gather feedback from beginners. As a result four users reported that they found the *Lip Plate* section too sensitive when it changed between colors (red and green). Two users reported that it showed a lot of information at once to focus, although they were told to focus only in one section at a time. Another user claimed that the augmented flute would be better for a beginner who knows already how to play the flute.

Continuous feedback is needed

Too much information to focus

Regarding hardware, one user reported a slightly heavier flute than normal, but that in despite of this, it did not affect him. Another user recommended the use of external batteries to reduce cable run. The survey results are shown in Figure 4.3. The y-axis shows the results in percentage ( $N = 5$ ). Question *a* shows disagreement ( $Median=4, SD=1.34$ ). The results from question *b* ( $Median=3, SD=1.48$ ) and question *c* ( $Median=3, SD=1.58$ ) did not yield any concrete results.

The augmented flute is heavier than other flutes

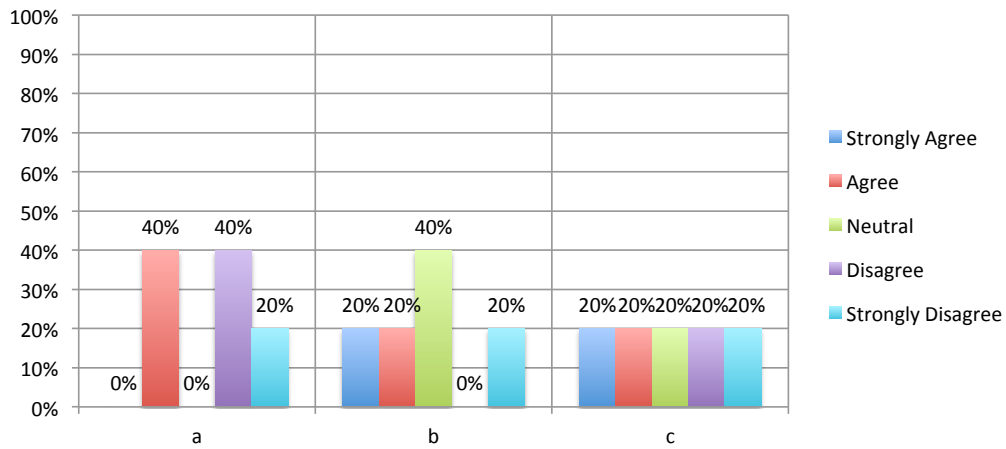

**Figure 4.3:** Results from usability questionnaire of first iteration: a) I could easily detect which parameter to change to get a better result, b) I felt supported by the augmented flute, c) I could easily find out how to get a better result

Noticing all the sections was difficult

We suspect that the results in question *a* were a result of too much information being played at once.

### 4.3 Second iteration with beginners

Continuous feedback was added in all sections of the interface

Before reaching this iteration, we performed small experiments to test the continuous and directional feedback. As a result, the second iteration included continuous feedback in all the sections (Third design). The *Frequency* section was changed to be instructional instead of being only informative, which could potentially give better results. Moreover, in order to decrease the cognitive load, each part was shown incrementally. That means, only the *Lip Placement* section was shown, then the *Lip Placement* section and the *Jet Direction* section finishing with all sections at the end. The order in which the sections appeared was changed according to task complexity. The *Lip Hole Shape* section was moved after the *Jet Direction* section because the task required some sound quality control that we believed was more difficult to handle than controlling air jet direction. Moreover, the *Lip Hole Shape* section showed more information than the *Jet Direction* section. Thus, Lip Placement and

Each part was shown incrementally

Order of the sections was changed



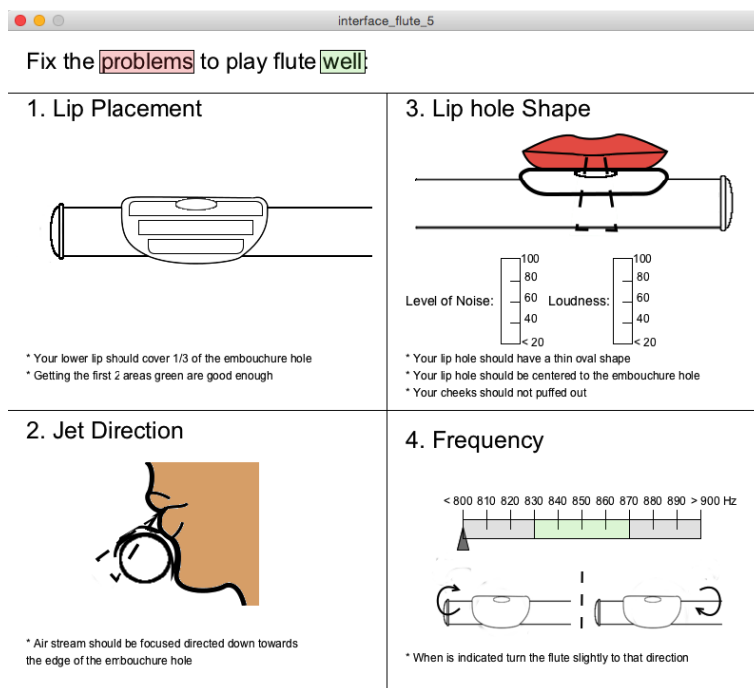

**Figure 4.4:** Second iteration interface with all sections enabled

Jet Direction were placed at the beginning i.e. 1) Lip Placement, 2) Jet Direction, 3) Lip hole Shape and 4) Frequency. The apparatus, case study design and questionnaire remained the same for this iteration.

#### 4.3.1 Task

The first part of the experiment (introduction) remained the same as the previous iteration. In the second part, we changed the presentation of the interface sections. We showed each section of the interface incrementally (i.e. 1st section, 1st & 2nd section, 1st & 2nd & 3rd, 1st & 2nd & 3rd & 4th). In Figure 4.4, we showed the interface of the application with all the sections enabled.

### 4.3.2 Participants

Five beginners participated. One reported to have played a wind instrument. The experiment followed a between-subject design.

We gathered five beginners for this study: 2 males and 3 females. Four of them were between 26-39 years old and one participant of 12-25 years old. None reported to have played flute before but other musical instruments: recorder, piano and guitar. The study was a between-subject study. Three participants were exposed to a normal head joint of the flute (without any sensor) to identify if they could play flute easily. Only some of the participants were presented with this task to avoid any bias on the performance. Only one participant produced sound, but the output sound was a whistle, which was not the fundamental frequency.

### 4.3.3 Results

Video observation was coded with 6 statements

The video recording was analyzed in depth, and the observations were coded with 6 statements for each section:

- Code – It is the user’s identification assigned to each participant.
- Action – The action performed during the section presented.
- Outcome – It established whether the action performed was successful or not.
- Consequences – Indicated the outcome of the interface.
- Causes – Described the possible cause of the outcome from our observations.
- Doubts – Exposed the doubts from the participants.

#### *Lip Placement section - Observations*

We coded our observations using the six statements mentioned above. The observations reported on Table 4.1 are based on the first trial.

Code	Action	Outcome	Consequences	Causes	Doubts
ww	Place and blow	Succeeded	The first bar was greener than the others (light green)	—	Which level of green was correctly enough
ll	Place and blow	Failed	The two lower bars were green	User mental mode ordered the bars from bottom-up	—
zz	Place and blow	Succeeded	Three bars were green	—	—
hh	Place and blow	Partially success	First upper bar were green and other bars were light-green	—	Which level of green was correctly enough
aa	Place	Succeeded	Three bars were green	—	—

**Table 4.1:** Observations of the Lip Placement section coded in 6 statements

User *ww* stated “Very helpful to know where exactly your lip is”. Between all the tasks, this task got the best results (3 from 5 participants). In this task, they could place their lips or place and blow as both actions can be validated by the system. Regardless of whether this task was performed well or not, the subjects had doubts of how green the indicator should be.

Doubts about how much green should be reached

The continuous feedback gave positive results, which is surprising compared to the first versions of the software. This might be because the continuous feedback was clearer and natural (lip covering was represented by a degraded color between white, green and red).

Continuous feedback gave good results

#### *Jet Direction section - Observations*

The observations are coded in Table 4.2 and are based on the first trial. They described the animation (the color, triangle size and angle) obtained as an output of the

<p>Performance agreed with the output of air jet direction section          Repetition improve first section performance</p>	<p>air jet executed. Since the user had to go through the <i>Lip Placement</i> section first, the table reports the output regarding only this section, <i>Jet Direction</i>. We noticed that all participants fulfilled the <i>Lip Placement</i> section correctly before trying the next section (<i>Jet Direction</i>). Two participants performed the new section correctly. The other three participants tried to solved the wrong jet angle by changing their lip placement e.g. by turning in the flute or lowering their lips position. That was effectively reflected in the output of the <i>Lip Placement</i> section. One case was, for example, participant <i>hh</i> turned in the flute, which only obtained the upper bar green. This indicated that she was not placing her chin on the lip plate.</p>
<p>3 tried to solve the problem wrongly</p>	
<p>Directional feedback was not enough</p>	<p>The results show that the augmented flute interface was able to describe correctly the direction of the executed air jet. In the other hand, we believe that the directional feedback was not sufficiently explanatory to give adequate direction to fulfill this task.</p>
<p>Effective detection of noisy tones but needs more precision          Bars were informative but confusing</p>	<p><i>Lip Hole Shape section - Observations</i>          The results are reported in Table 4.3. The observations correspond to the first performed trial. The Algorithm 3 could detect a very noisy tone however, it was not precise (<i>ww</i> obtained green-red loudness level and still the air jet of the lip hole showed green). Regarding the Level of noise and Loudness bars, we found that they can be informative, but for some beginners it was confusing and for others it was not relevant.</p>
<p>Tension on the lips were observed</p>	<p><i>Frequency section - Observations</i>          The results for this section are shown in Table 4.4. Participant <i>ww</i> reported that playing the correct frequency helped him to correct the loudness bar of the <i>Lip Hole Shape</i> section. Participant <i>ll</i> performed well in the previous section (<i>Lip Hole Shape</i>), but in this section, she changed her embouchure placement, and the new placement was incorrect (her lips were rolled over her teeth). We also noted tension on the participant lips. Furthermore, there was some confusion about turning the flute in/out. Two out of five participants thought to tilt instead of turning. After the explanation, they could perform the movement well. Regard-</p>
<p>Two participants tilted the flute instead of turning</p>	

Code	Action	Outcome	Consequences	Causes	Doubts
ww	Place and Blow	Succeeded	Green color was obtained. Triangle area mostly matched the indicated area	The user changed his chin position to try out different air jet direction	—
ll	Place and Blow	Failed	Red color was obtained and the triangle area was small and towards inside the flute	The air jet was directed mostly to the embouchure hole because her lips were placed too low	Participant could not recall how to place her lips
zz	Place and blow	Partially success	Output color was between red and green. The triangle area size was about half of the indicated area and its angle was slightly towards inside the flute	User's upper lip was forwarder than the lower lip	—
hh	Place and blow	Partially success	Output color was between red and green. The triangle size was about half and its angle was towards inside the flute.	User changed her lip shape to duck lip shape (at first glance of the picture). Also the flute was turned in too much	—
aa	blow	Succeeded	Gradually the triangle filled the area indicated. The colored area started red and ended green	The sensor took time to warm up	—

**Table 4.2:** Observations of the *Jet Direction* section coded with 6 statements

Code	Action	Outcome	Consequences	Causes	Doubts
ww	Place and Blow	Partially success	Animation reached green as well as Level of noise bar. Loudness bar showed green-red. Sound was produced.	A slightly wide lip hole	How to correct Loudness
ll	Place and Blow	Partially success	Animation reached red, Level noise and Loudness bars showed green-red. Sound was produced.	The lips were rolled over the teeth	—
zz	Place and Blow	Failed	Animation almost completed the indicated area. Bars were empty.	Upper lip was more forward with respect the lower lip. Lip hole was very thick. No sound was produced.	—
hh	Place and Blow	Partially success	Animation reached red, Level noise and Loudness bars were green-red	The flute was turned in too far. Size of the lip hole was slightly thick.	—
aa	Place and Blow	Partially success	Animation reached red, Level noise and Loudness bars showed green-red.	A thick lip hole	The two bars were confusing and not enough information on how to perform a proper loudness.

**Table 4.3:** Observations of the *Lip Hole Shape* section within 6 statements

Code	Action	Outcome	Consequences	Causes	Doubts
ww	Blow	Succeeded	Frequencies around 850 Hz were produced	User turned in/out the flute as indicated	—
ll	Blow	Failed	No sound was produced. High presence of wind noise (nail indicator was mostly on the right)	The flute was turned in too much, also the lips were rolled over her teeth. The turning in/out movement was not performed.	Participant was unsure how her lip position should be on the lip plate.
zz	Blow	Failed	No sound was produced. High presence of wind noise. (nail indicator was mostly on the right)	At the beginning, user tilted the flute instead of turning in/out it also, user upper lip was too forward with respect to lower lip.	—
hh	Blow	Succeeded	Different frequencies were produced around 850 Hz	—	Asked about turning direction and Frequency term
aa	Blow	Failed	Whistle of 1.6Khz was produced. Nail indicator was mostly in the right	Lip hole shape does not seem to have a longitudinal shape (video observation)	—

**Table 4.4:** Observations of the *Frequency* section coded with 6 statements

The output of the interface was compared to an expert opinion

ing the text displayed, only one participant asked about the meaning of the term Frequency.

*Interview with an expert about participants' performance*

In order to validate our results, we interviewed an experienced flutist to judge the performance of the participants. The instructor, Sandra Fernández, has 18 years as a flute performer and 5 years as a private instructor and is currently a PhD candidate in Flute Performance at the University of Missouri-Kansas City. Ms. Fernandez reviewed the videos obtained from the participant tests and sent comments about the observed performance. Here, we summarize, her observations, comparing those with the results from the augmented flute application output:

- **Fernandez:** the embouchure of participant *ww* was fair, but *ww* left much of the embouchure hole area uncovered, hence the tone was noisy.  
**Application:** positive result in section 1 (lip placement). Noise Level indicator was green.  
**Assessment:** Partial agreement as one of the three capacitive sensors (Y sensor) and the Noise indicator were not accurate.
- **Fernandez:** Participant *ll* had rolled her lips too much over her teeth. Much of the airflow was directed into the embouchure hole because of the way the participant held the flute.  
**Application:** *Jet Direction* section showed that the air jet was directed into the flute.  
**Assessment:** Partial agreement as the application cannot detect the way the lips are rolled, but air jet direction agreed with the second observation.
- **Fernandez:** The embouchure hole was not covered enough by the lower lip of participant *zz*. In addition, the participant *zz* directed the air mostly towards the insides of the flute.  
**Application:** *Lip Placement* section had all three bars green often and in *Jet Direction* section, the air jet direction was shown going into the flute.  
**Assessment:** Partial agreement as the participant covered the lip placement sensors by the area below



the lower lip and there is no way to detect which part exactly covers the sensors. The air jet direction however does agree with the second observation.

- **Fernandez:** The participant *hh* did not place the chin and lower lip properly on the flute and her face looked tense. The upper lip was slightly ahead compared to the lower lip and the flute was rolled with the embouchure hole oriented more towards the mouth.

**Application:** *Lip Placement* showed green only for the upper bar and the air jet direction was shown going inside the flute.

**Assessment:** Partial agreement as the application does not detect the upper lip position, but the lip placement and air jet direction agreed with the observation in general.

- **Fernandez:** Participant *aa* presents a problem with the air jet angle. The sound produced by *aa* was similar to a harmonic. This could be possibly due to an air jet angle with more air going out of the flute than optimum with a wide lip hole.

**Application:** Air jet direction was positive and the Lip Hole Shape section showed a wide lip hole.

**Assessment:** Partial agreement as the air jet direction was not accurate, however the Lip Hole Shape and Frequency section agreed with the observation.

Overall, the application partially agreed with the expert's observations. Additionally, we found that the augmented flute is not able to detect how much lower lip is being used and rolled lips, but the effects of them regarding air jet angle and noise could be detected.

Expert opinion  
agreed in some level  
interface output  
Amount of lower lip  
(red part) cannot be  
detected

#### *Results from the usability questionnaire*

The results obtained from the usability questionnaire showed improvement compared to the first iteration with beginners. Results are shown in Figure 4.5. Additionally, we applied a non-parametric test, the Mann Whitney U test, since the data collected (10 samples) was not normally distributed. We compared the last two designs used for testing beginners' interaction. The first iteration (with begin-

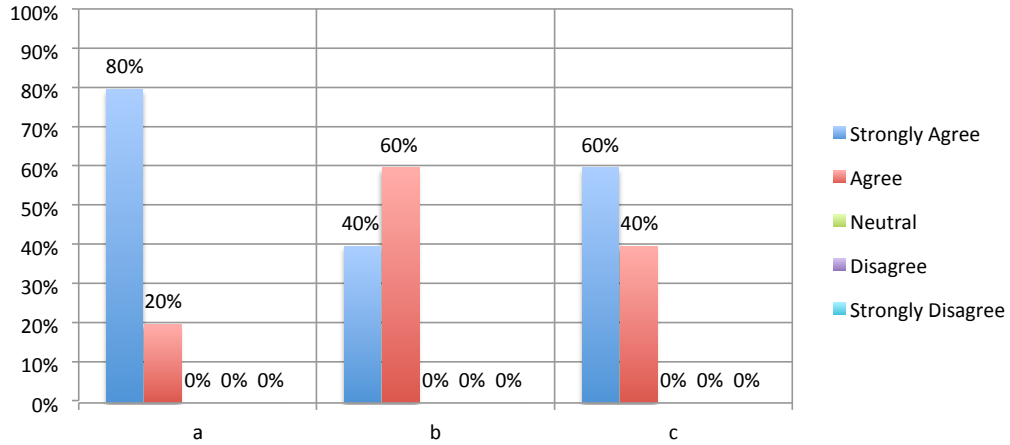

**Figure 4.5:** Results from usability questionnaire of second iteration with beginners: a) I could easily detect which parameter to change to get a better result, b) I felt supported by the augmented flute, c) I could easily find out how to get a better result

Results were improved  
Question *a* had a  $p < 0.05$

ners) employed the second design and second iteration employed the third design. We compared the mean rank for each question and it showed a higher rank for the third design. However, only the question *a* had a  $p$  value less than 0.05. That means, it was easier to detect which parameter to change using the third design than the second design.

Tables 4.5 and 4.6 show the results and the output of the statistical test respectively.

Ranks				
Question	Design	N	Mean Rank	Sum of Ranks
<i>a</i>	2	5	3.20	16.00
	3	5	7.80	39.00
	Total	10		
<i>b</i>	2	5	4.10	20.50
	3	5	6.90	34.50
	Total	10		
<i>c</i>	2	5	3.90	19.50
	3	5	7.10	35.50
	Total	10		

**Table 4.5:** Mann-Whitney U test - Ranks

Test Statistics			
	<b>a</b>	<b>b</b>	<b>c</b>
Mann-Whitney U	1.000	5.500	4.500
Z	-2.520	-1.534	-1.747
Asymp. Sig. (2-tailed)	.012	.125	.081

**Table 4.6:** Mann-Whitney U test - Test statistics



## Chapter 5

# Summary and recommendations

In this work we designed and evaluated an augmented flute for beginners. We found that the augmented flute was able to detect and show in real time, problems regarding the embouchure. The augmented flute improved its usability employing continuous and directional feedback (Table 4.6) and it was helpful in most cases, to address some of the problems, but not completely. It was found that introducing each section step by step, gave better results than showing all sections at once. Moreover, in the second test (with beginners), all those who obtained partially success or succeeded in all 4 stages, produced sound. This gives consistency between the performance and the output of the system.

The results show that the augmented flute can be beneficial, further studies are needed with a greater population in order to be able to reach a definitive conclusion. Furthermore, learning an instrument has a time factor of practice in order to be learned effectively in order to learn a task successfully. Since the study was meant to evaluate the interaction between subjects and the flute, and the immediate results, the repetitive element that is part of the learning process was not evaluated, therefore the participants were not asked to do more than a couple repetitions. We believe that using the augmented flute in more than one session

The augmented flute could make visible embouchure problems

Feedback was helpful but needs more instructions

Augmented flute can be beneficial

could improve the results.

Innovated way to  
measure  
embouchure  
parameters

We had introduced an innovative approach to measure embouchure gestures adding sensors on the head joint of the flute. The capacitive sensors could detect the lip plate effectively. Also, the augmented flute could track the air jet direction using two airflow sensors strategically located without losing the main acoustic properties of the instrument. Furthermore, the output of the augmented flute versus the observations of the expert are very close, but more data is needed to obtain a more accurate threshold. We believe that the feedback provided by the augmented flute, certainly reflects the performance of the player, which can be very useful for the teacher to recognize problems in the studio.

More data is needed  
to add more  
precision

## 5.1 Limitations

Experiment  
performed in a  
controlled  
environment

The augmented flute was tested in a laboratory within a controlled environment that does not resemble a real flute class. A normal classroom can be exposed to higher environmental noise due to the equipment employed or the surroundings. Additionally, the augmented flute was tested with participants older than 12 years old, thus for children the augmented flute might need further adjustments to suit their needs.

The augmented flute  
might not be suitable  
for children

The augmented flute  
cannot be used  
alone

We used lightweight sensors to measure directly the embouchure gestures. As a result, there are gestures that cannot be detected because they go beyond their scope e.g. tension around the mouth, rolled lips over the teeth and forwarder upper lip. Therefore, the augmented flute cannot be used alone with beginners without any introduction or guidance. We believe that using the augmented flute with a flute teacher will yield the best results.

## 5.2 Recommendations

From the evaluations we found some suggestions that could improve the usability of the augmented flute interface. For example, adding help videos for each parameter, showing the player how to carry out the task, along descriptive information about the target zones and ways to reach those zones could clarify the path to reach the goals for each task. Regarding the *Lip Hole Shape* section, we found that the bars for noise level and loudness were complex for a beginner. Also, in the *Frequency* section, the drawings can be improved by integrating 3D illustrations and pointers, so that any misinterpretations can be avoided.

Add helper videos and more descriptive information

Bars can be optional

Regarding the capacitive sensors of the augmented flute, we recommend disconnecting and connecting the USB connection when the rectangles on each sensor do not show a *white* state when launching the application. We noticed that after sometime playing, the capacitive foils did not discharge completely, thus disconnecting the source of power and cleaning the foils solved this issue. It is also recommended during the prototype building stage, to check the ground connection. When building the initial versions of the augmented flute, we noticed, if the ground connection was not properly done, just touching the flute influenced the data; also the wires from the foils to the micro-controller should be tight enough to avoid movement that could produce variations in the data flow. We recommend adding a case for the airflow sensor outside the flute, especially if it will be used with children, since the airflow sensors deploy heat. Although, we did not have problems with our participants (they were informed beforehand), a case is recommended for safety.

Restart the system to discharge the foils

Check ground connection

Add protection to airflow sensor

## 5.3 Recommendations for future work

So far, the augmented flute can show graphically, embouchure problems during the performance. Also it provides directional feedback to solve the problems regarding the embouchure (lip covering, air jet and lip hole). How-

Higher level of rules between sections

ever, other problems might arise and may go unnoticed. This can be improved using a higher level of rules that uses the output of all other sections. For example, during testing we observed that when the flute was turned in too much, the upper bar was active (*Lip Placement* section), the air jet direction was towards inside the flute and the tone had a lower frequency. These three indicators combined can provide more intelligent suggestions to the player.

Research impedance  
of the augmented  
flute

Regarding the design of the augmented flute hardware, there were no comments from the experienced flutist about it being difficult to play, but it would be interesting to know if the current setup changes or not the impedance of the airflow vibration. Additionally, it would be of interest to find whether adding more weight to the augmented flute (and in the case of a battery) affects the performance of the player.

The augmented flute  
as a training tool for  
teaching

There are some questions regarding the use of the augmented flute in the long term. The effectiveness of the augmented flute as a training tool, or at which point the augmented fluted would be most effective or beneficial, are topics that could bring another level of understanding in the learning process as well as developing a new pedagogy involving the augmented flute.

Extend to higher  
levels

Different versions could be built for different levels, intermediate or advanced removing the flow sensor inside and focusing on the quality of tone, playing between octaves or involving other parts of the flute (body and foot joint of the flute). Also, the airflow sensor outside could be redesigned to be movable in order to allow the performer to select a steeper or lower angle. The augmented flute might also be used as a tool to trigger effects, in contemporary performances.

As a tool to expand  
musical expression



## Appendix A

# The augmented flute circuit

### A.1 Flow sensor setup

In order to sense the airflow, we used a Thermal Mass Flow Sensor, fs5, from Innovative Sensor Technology (IST). The setup for this sensor is shown in Figure A.1. This circuit uses a transistor to control the voltage supplied through Arduino. D5 is the port where Arduino sends high/low voltage and A4 is the input port that obtains the values from the flow sensor.

Circuit uses fs5 and a transistor to control power supply

#### Temperature control

During 40 milliseconds, 5 volts were sent to the sensor and then turned off. This was executed if the ADC returned codes were below 300, otherwise it remained turned off. This way, the heat of the sensor could be maintained around 27 degrees Celsius.

Alternating power on/off to hold the temperature

### A.2 The augmented flute schematic

Figure A.2 shows the schematic of the augmented flute circuit. Originally, the augmented flute was designed to have

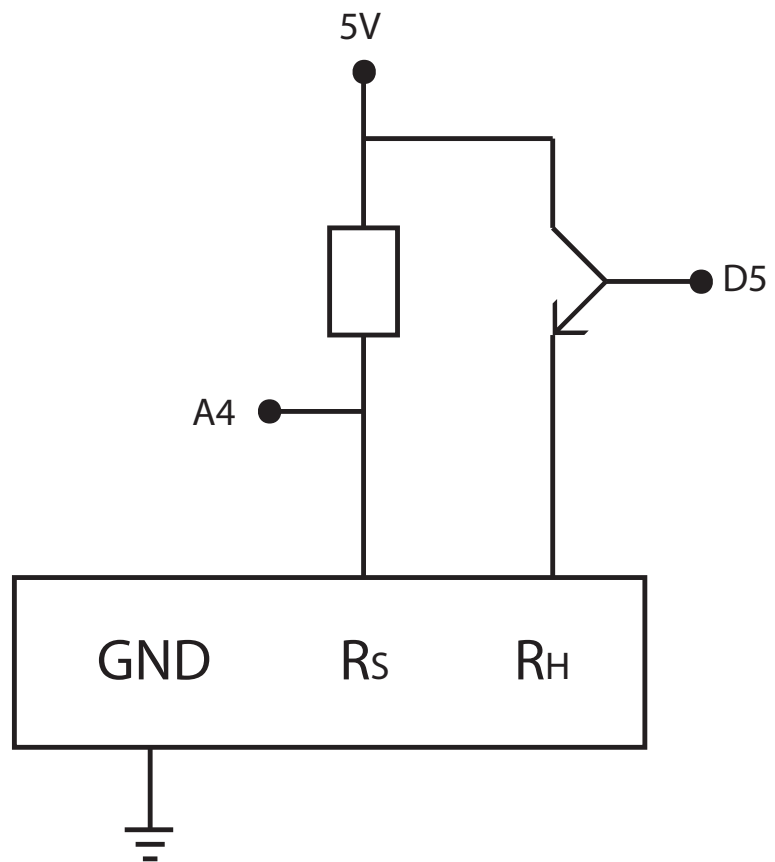

**Figure A.1:** Circuit to control supplied voltage to flow sensor through Arduino. GND is ground,  $R_s$  sensor pin,  $R_H$  heater pin

battery support, however, it was discarded later as to avoid adding more weight to the system.





---

## Appendix B

# Audio processing with PureData

PureData defines small programs as a patch that can be part of other programs. The input of the patch is called “inlets” and the output “outlets”. The patches that use audio signals need “tilde” besides the name of the patch (e.g. *osc~*).

A program in Pd is called patch

We created a patch that processes the audio signal of a microphone and retrieves, frequency, signal volume and filtered signal volume. The idea was to obtain frequency, signal level, and signal level without harmonics from a flute tone. With those values, we could find the noise-tone proportion for the augmented flute program (see chapter 3).

Patch process audio signal from a microphone

The patch initially stores 1500 ms into a buffer called *platz*. The buffer is needed in order to analyze the signal; therefore, we delayed the signal by 500ms. In order to do that, we used the patches: *sig~* and *vd~*. The first one converts a number into an audio signal, and the second one delays the signal with a delay interval specified in its left inlet. We used *sigmund~* patch to get the fundamental frequency and *pitchEnv~* to attenuate the harmonics (fundamental included) and obtain the residual signal. Both patches used the same window size of 4096 samples. As *sigmund~* outputs the pitch of the signal in dB, we used *mtof~* to convert it to Hertz. The patch *env~* outputs the volume of a signal in decibels. Then, with the patch *pack~*, the data is

Patch description

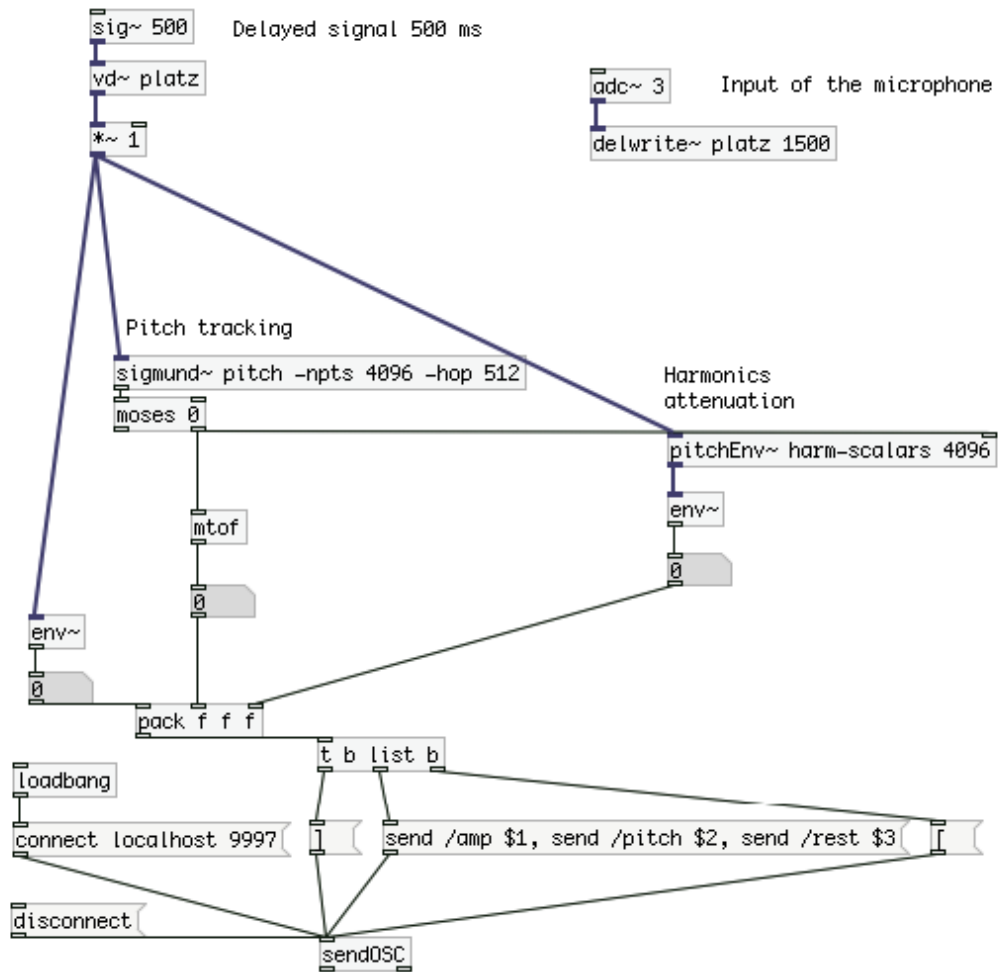

**Figure B.1:** PureData patch to retrieve frequency, amplitude of the residual signal and amplitude of the signal itself

packed and sent through the network. Figure B.1 shows all the patches used.

## Bibliography

American heritage® dictionary of the english language, fifth edition. Sep 2015. URL <http://www.thefreedictionary.com/embouchure>.

Joseph-Henri Altès. *Method for the Boehm Flute*. Carl Fischer, 1897.

Arthur H Benade and JW French. Analysis of the flute head joint. *The Journal of the Acoustical Society of America*, 37(4): 679–691, 1965.

Herbert Blocki and Martin Blocki. Air flow visualization teaching apparatus, June 4 2002. US Patent 6,399,867.

Ted Boehm, Theobald Boehm, and Dayton C Miller. *The flute and flute playing*. Courier Corporation, 2011.

Arthur Brooke. *The modern method for Boehm flute/by Arthur Brooke*. 1912.

Melissa Bugner. Flute teaching tape, 2014. URL [https://youtu.be/M8b\\_FIArc-I](https://youtu.be/M8b_FIArc-I).

Annie S. Chung and Zachary Chen. Flute teaching video (beginner) a, 2013. URL <https://www.youtube.com/watch?v=2t4lBNOzGaY>.

John W Coltman. Resonance and sounding frequencies of the flute. *The Journal of the Acoustical Society of America*, 40 (1):99–107, 1966.

Andrey R Da Silva, Marcelo M Wanderley, and Gary Scavone. On the use of flute air jet as a musical control variable. In *Proceedings of the 2005 conference on New interfaces for musical expression*, pages 105–108. National University of Singapore, 2005.

- Burke Davison. An1334: Techniques for robust touch sensing design. Technical report, Microchip Technology Inc., 2012.
- Neville H Fletcher. Some acoustical principles of flute technique. *The Instrumentalist*, 28(7):57–61, 1974.
- Neville H Fletcher. Acoustical correlates of flute performance technique. *The Journal of the Acoustical Society of America*, 57(1):233–237, 1975.
- Neville H Fletcher and Thomas Rossing. *The physics of musical instruments*. Springer Science & Business Media, 2012.
- Pupa Gilbert. *Physics in the arts*. Academic Press, 2012.
- Geddy Grove. Flute teaching video part 1, 2014. URL <https://www.youtube.com/watch?v=G7vh3aN1xmU>.
- T Machover. Hyperinstruments: A progress report 1987-1991. media lab document, 1992.
- Susan Maclagan. *A dictionary for the modern flutist*. Scarecrow Press, Lanham, Md, 2009. ISBN 9780810867284.
- Katie McClanahan. Flute teaching activity, 2014. URL [https://www.youtube.com/watch?v=wztW618\\_Mp0](https://www.youtube.com/watch?v=wztW618_Mp0).
- Marcel Moyse. *De la sonorité: art et technique*. Alphonse Leduc, 1946.
- Cléo Palacio-Quintin. The hyper-flute. In *Proceedings of the 2003 conference on New interfaces for musical expression*, pages 206–207. National University of Singapore, 2003.
- Cléo Palacio-Quintin. Eight years of practice on the hyper-flute: Technological and musical perspectives. In *Proceedings of the International Conference on New Interfaces for Musical Expression*, pages 293–298, 2008.
- Edwin V. Putnik. *The Art of Flute Playing*. Alfred Music, 1970.
- Ross Quinlan. *C4.5: Programs for Machine Learning*. Morgan Kaufmann Publishers, San Mateo, CA, 1993.



- David Rincon L. and Katherine Galeano R. Non-immersive virtual reality: Electronic instrument to learn to play a flute. 2011.
- Gary P Scavone. The pipe: explorations with breath control. In *Proceedings of the 2003 conference on New interfaces for musical expression*, pages 15–18. National University of Singapore, 2003.
- Diana Siwiak, Ajay Kapur, and Dale A Carnegie. Music technology’s influence on flute pedagogy: A survey of their intersection. 2014.
- Jorge Solis, Massimo Bergamasco, Keisuke Chida, Shuzo Isoda, and Atsuo Takanishi. The anthropomorphic flutist robot wf-4 teaching flute playing to beginner students. In *Robotics and Automation, 2004. Proceedings. ICRA’04. 2004 IEEE International Conference on*, volume 1, pages 146–151. IEEE, 2004.
- Toshio Takahashi. *Suzuki Flute School, Volume 1: Flute Part*. Alfred Publishing, 1999. ISBN 0874871654.
- Ernest Frederick Wagner. *Foundation to flute playing: an elementary method*. Carl Fischer, 1918.
- Marcelo M Wanderley and Philippe Depalle. Gestural control of sound synthesis. *Proceedings of the IEEE*, 92(4):632–644, 2004.
- David Wang. Fdc1004: Basics of capacitive sensing and applications. Technical report, Texas Instruments, 2014.
- Maggie Watts. Flute teaching assessment - watts, 2013. URL [https://www.youtube.com/watch?v=zZ\\_n8d6eKt8](https://www.youtube.com/watch?v=zZ_n8d6eKt8).
- Gerda Reinette Wilcocks. *Improving Tone production on the flute with regards to embouchure, lip flexibility, vibrato and tone colour, as seen from a classical music perspective*. PhD thesis, University of Pretoria, 2006.
- Allison Yerkey. Flute teaching tape part 1, 2014. URL <https://www.youtube.com/watch?v=QPJ4dIs9xgA>.
- Sølvi Ystad and Thierry Voinier. A virtually real flute. *Computer Music Journal*, 25(2):13–24, 2001.

M Yunik, M Borys, and GW Swift. A digital flute. *Computer Music Journal*, pages 49–52, 1985.

# Index

“piu” exercise, 17

acquisition of a gesture

- direct, 19
- indirect, 19

ADC, 27

air jet, 10, 12

- off-centered, 9
- speed, 12
- strength, 12, 18

air jet angle, 7

air stream, 7

airflow sensor, 25

- fs5, 27
- inside the flute, 26
- outside the flute, 25

Altès, 6

Arduino Leonardo, 19

Arduino Micro, 24

Arthur Brooke, 6

assist learning, 15

augmentation requirements, 19

augmented flute, *see* augmented instruments

augmented instruments, 14

bars, 52

battery consumption, 32

beginners’ problems, 17

Bernoulli’s principle, 25

Blocki method, 15

blowing pressure, 12, 13

Boehm’s design, 10

bore, 10

boundary conditions, 11

Capacitive Sensing Library, 25

capacitive sensor, 19, 71

- first setup, 21

- second setup, 22
- cheeks, 8, 18
- Coltman, 12
- continuous and directional feedback, 41, 56, 59, 60
- data classification, 37
- differential amplifier, 19, 27
- embouchure, 7
  - corrections, 17
  - gestures, 12
  - parameters, 19
  - problems, 7, 18
- embouchure hole, 7, 10
  - covering, 7, 13, 19
  - uncovered, 13
- evaluation, 66
- experienced flutist, 36, 64
- Fletcher, 12
- flute body, 5
- flute instructors, 17, 18
- flute pedagogy, 15
- flute technique, 5
- foils placement, 20
- foot joint, 5
- Fourier analysis, 29
- frequency, 11
  - higher frequency, 13
- fundamental frequency, 11, 13, 30
- future work, 72
- gesture, 14
- ground connection, 21
- harmonics, 11, 13, 29
- head joint, 5, 10
- high pressure, 10
- Hyper-flute, 14
- impedance of the airflow, 27
- instrument-like, 14
- insulator, 21
- intelligent suggestions, 72
- jet angle, 13
- jet length, 12
- lip covering, *see* embouchure hole covering
- lip hole, 6

- gesture, 29
- shape, 12, 13, 29
- lip plate, 5, 10
- lips
  - lower lip, 7
  - position, 6, 18
  - upper lip, 9
- low pressure, 10
  
- magnetic sensors, 14
- Main Program, 33
  - first design, 34
  - second design, 39
  - third design, 41
- Mann Whitney U test, 65
- Moyse, 12
  
- noise proportion, 29, 31
  
- octave, 9, 13
- open pipe, 10, 11
- Open Sound Control (OSC), 30, 33
- ownwork, 46
  
- parasitic capacitances, 20
- participants, 49, 54, 58
- physical aspects, 5, 12
- physical constraints, 8
- pitchEnv patch, 29
- pressure anti-node, 10
- pressure nodes, 10
- PureData, 29, 33
- Putnik, 7
  
- questionnaire, 49, 54
  
- real time features extraction, 29
- relatedwork, 16
- robots assistants, 15
  
- sigmund patch, 29
- signal to noise ratio (SNR), 20, 21
- speed of the sound, 12
- standing waves, 10, 11, 25
- synthesize, 14, 31
  
- Thresholds, 36
- tone
  - breathy, 9
  - dull, 7

- fuzzy, 9
- non-clean, 8
- sharp, 13
- windy, 9
- transverse flute
  - key holes, 5
  - parts, 5
- turning the flute, 7, 13
  
- user study, 47
  - with beginners, 52, 56
  - with experienced flutist, 47
  
- video observation coded in six statements, 58
- visual representation, 18
  
- wavelength, 12
- WEKA, 37
- William Brent, 30
- windy noise, 29

